

TABLE OF CONTENTS

Water-to-Air Heat Exchanger Products	2-4
Pumps and Pump Accessories	5
PEX Pipe, Fittings and Related	6
PEX Pipe Related, ThermoPEX and Central Therm	7
Manifolds and Water-to-Water Exchangers	8
Water-to-Water Exchangers	9
Connections, Solder and Flux	10
Valves, Manifolds, Strainers, Connections, Adapters	11-12
Thermostats, Transformers, Aquastats	13
Baseboards, Copper Connections	14
Push-fit Fittings	15
Maintenance, Replacement and Optional Products	16
Maintenance, Replacement and Optional Products - Classic and Pallet Burner	17-18
Maintenance, Replacement and Options Products - E-Classic	19-21
Chimney Components - Classic, E-Classic and Pallet Burner	12-23
Maintenance, Replacement and Optional Products - Maxim	24-26
Chimney Components - Maxim	27
NUMERICAL PARTS LIST	28-29
Definitions	30
SYSTEM DIAGRAMS	31-38
DIMENSIONS AND MEASUREMENTS	39-40
SAMPLE PARTS LIST	41

NOTE

All installations must be performed by a qualified installer and in accordance with any and all federal, state/provincial and local codes and regulations. When performing work on an appliance observe all precautions in the literature, tags and labels attached to the appliance and other safety precautions that may apply. When working with electricity and electrical components, failure to follow precautions could result in property damage, personal injury or death.

ALPHABETICAL INDEX

1-1/4" Thermostatic Valve.....	11	E-Classic 1400 Refractory Grates.....	19	Pipe Plug.....	10
1-1/4" Thermostatic Valve Fittings Kit.....	11	E-Classic 1450 Refractory.....	19	Pipe Plug Wrench Set.....	10
2-Stage Gas Regulator Kit.....	21, 26	E-Classic 1450 Stainless Steel Chimney Sections.....	22	Plate Heat Exchanger.....	8
2-Way Zone Valve, 24-Volt.....	13	E-Classic 2300 Refractory Grates.....	20	Plate Mounting Bracket.....	8
3/4" Thermostatic Valve.....	11	E-Classic 2400 Refractory.....	20	Plug-in Thermostat.....	13
3/4" Thermostatic Valve Fittings Kit.....	11	E-Classic 3200 Refractory.....	20	Pool Aquastat.....	13
3/8" Cleaning Rod.....	25	E-Classic Stainless Steel Chimney Section.....	22	Power Supply Cord.....	5
3-Way Valve.....	11	Elbow.....	15	Programmable 24-Volt Thermostat.....	13
3-Way Zone Valve, 24-Volt.....	13	Fan Center Relay.....	16	Propane Shut-off with Level Indicator.....	25
6" Chimney Band Clamp Kit.....	22, 28	Fan Convactor (26k Btu).....	3	Pulse Timer Kit.....	20
6" Chimney Cap.....	22, 28	Female Adapter.....	6	Pump Flange Kits.....	5
6" Chimney Guy-Wire Band.....	22	Female Adapter, 3/4" Hose.....	12	Pump Wall Mount Kit.....	5
8" Chimney Band Clamp Kit.....	23	Female Adapter, Copper.....	14	Purging and Filling Tee.....	12
8" Chimney Base Brace Kit.....	23	Fin Comb.....	16	Push-fit Fittings.....	15
8" Chimney Guy-Wire Band Kit.....	23	Firebox Temp Sensor.....	26	Push-fit Fittings Water Heater Kit.....	15
8" Spark Arrestor.....	23	Firebrick.....	19	Ratchet Cinch Tool.....	6
24-Volt Transformer.....	13, 25	Fittings Kit, Threaded.....	8	Reaction Chamber Thermocouple.....	20
45' Street Elbow.....	10	Fixed Aquastat, 175°F.....	13	Reducer, Copper.....	14
48-Bushel Hopper Kit.....	24	Floor Fan Convactor.....	4	Reducing Tee, Copper.....	14
90' Elbow, Copper.....	14	Flow Check Valve.....	8	Relay.....	25
90' Reducing Elbow, Copper.....	14	Flue Brush & Handle.....	20, 26	Relay Kit, Solid State.....	18
90' Street Elbow.....	10, 14	Fuse Holder & Fuses.....	18	Rocker Switch.....	18
Adjustable Aquastat, Immersible.....	13	Fuse & Socket.....	16	Round Pipe Caps.....	25
Adjustable Aquastat, Surface Mount.....	13	Fusion Combustor Kit.....	21	Secondary Air Charge Tube.....	19
Aerator.....	25	Gas Burner Kits.....	19	Selector Switch.....	18
Air Filter.....	3	Gas Burner Valve.....	19, 25	Sight Gauge Components.....	17
Air Handler Cabinet.....	4	Gas Hose w/Regulator.....	25	Silicone Door Seal.....	20
Air Proving Switch Replacement Kit.....	25	Gas Ignition Module.....	19, 25	Single-stage, Non-programmable 24-Volt Thermostat.....	13
Air Proving Switch Tubing.....	21	Grate Rod.....	19	Sludge Conditioner.....	16
Ash Rake.....	17	Grounding Rod Kit.....	16	Snap Disc.....	24
Ash Scoop.....	25	Guy-Wire Band.....	28	Solder & Soldering Flux.....	10
Ash Shovel.....	17, 21	Heat Exchanger Coil (50k Btu).....	2	Solenoid.....	18
Ashtrol.....	17	Heat Exchanger Coil (80k Btu).....	2	Space Heater (100k Btu).....	3
Automatic Vent Valve.....	9	Heat Exchanger Coil (95k Btu).....	2	Space Heater (140k Btu).....	3
Auxiliary Auger Kits for Maxim.....	24	Heat Exchanger Coil (100k Btu).....	2	Space Heater Cabinet (50k Btu).....	3
Auxiliary Auger Vibrator w/Timer Kit.....	24	Heat Exchanger Coil (125k Btu).....	2	Spacer Bar Kit.....	21
Backflow Preventer.....	12	Heat Exchanger Coil (140k Btu).....	2	Stainless Steel Chimney Tee Kits.....	22
Bag Holder Kit.....	24	Heat Exchanger Coil (185k Btu).....	2	Suspended Space Heater (100k Btu).....	2
Ball Valve.....	11	Heat Exchanger Coil (220k Btu).....	2	Suspended Space Heater (220k Btu).....	2
Baseboard, Complete.....	14	Heat Exchanger Mounting Kit.....	8	Sweat Ball Valve.....	14
Baseboard Corners.....	14	Heat Exchanger Scraper.....	20	Taco Pump Replacement Cartridges.....	5
Baseboard End Cap.....	14	HeatTrac Controller Update Kits.....	18	Taco Pumps - 006 Series.....	5
Baseboard Joiner.....	14	Hex Bushing.....	10	Taco Pumps - 007 Series.....	5
Battery Clean Out Kit.....	24	High Limit Switch/Snap Disc.....	18	Taco Pumps - 009 & 014 Series.....	5
Black Silicone Adhesive, High Temperature.....	16	High Pressure Gas Hose Adapter.....	26	Tee.....	10, 15
Blower Fan Assembly.....	19	Hoe.....	17	Tee, Copper.....	14
Blower & Motor.....	3	Hopper Extension Kit.....	24	Temperature Gauge Fitting.....	15
Brass Coupling.....	12	Hopper Lid Shock.....	24	Temperature Gauges.....	16
Brass Fittings for 1-1/4" PEX Pipe.....	12	Hopper Vibrator Kit.....	24	Temperature Sensing Wire.....	18
Brass Hex Bushing.....	10	Hot Filter & Cartridge.....	11	Tempering Valve.....	13
Brass Hose Bib.....	10	Ignitor Burner Gasket.....	20	ThermoPEX.....	7
Brass Offset Tee, 4".....	10	Ignitor - M250.....	25	ThermoPEX Coupling Kit.....	7
Brass Pipe Union, FIP.....	10	Ignitor Spark Plug Wire - M250.....	25	ThermoPEX Termination Cap.....	7
Brass Swing Check Valve.....	11	Ignitor Wire Assembly.....	25	Thermostatic Radiator Valves.....	9
Brass Tee, 3/4".....	10	Indoor Water Temperature Indicator Kit.....	16	Tile Tape.....	16
Burn Chamber Gasket Only.....	26	Inspection Window Components.....	26	Time Delay Relay.....	18
Burn Chamber w/Gasket.....	26	Insulation.....	24	Turbulator - E-Classic 2300.....	21
Burner Auger.....	26	Isolation Auger Motor Kit.....	25	Turbulator - M175.....	26
Burner Auger Motor.....	25	Isolation Flange Kit.....	5	Universal Heat Exchanger Mounting Kit.....	8
Cam Latch/Cam Loc Bushings with Collar.....	17	Isolation Flange with Drain Valve, 3/4".....	5	Vent Cap.....	24
Cast Iron Manifold.....	11	Kickspace Fan Convactor.....	4	Vent Cap - Classic Models.....	17
Central Boiler Clamp.....	6	Latch Spring Clip.....	19	Vent Elbow, Copper.....	14
Central PEX 1/2" Pipe.....	6	LED Replacement Bulb/Plug.....	21	Wall Mount Fan Convactor.....	4
Central PEX 1" Pipe.....	6	LED Temperature Display.....	18	Wall Mount Fan Convactor (7k Btu).....	3
Central PEX 1" Pipe Sections.....	6	Lens & Light Bulb.....	18	Water Level Float Switch.....	20, 26
Central Therm Insulation.....	7	Light Switch.....	18	Water Softener Cartridge.....	16
Central Therm Sleeve.....	7	Line Voltage Thermostat.....	13	Water Test Kit.....	16
Central Therm Sleeve Dispenser.....	7	Linkage.....	17	Water-to-Water Heat Exchanger, Double Wall.....	9
Chimney Attachment Ring.....	22, 23, 28	Louvers.....	2	Water-to-Water Heat Exchanger & Fittings Kit.....	9
Chimney Components.....	22	Male Adapter, 3/4" Hose.....	12	Water-to-Water Heat Exchanger, Shell & Tube.....	8, 9
Chimney Support Brace Kit.....	23	Male Adapter, Copper.....	14	Wonder Bar.....	20
Chimney Tee Covers.....	22	Manifold.....	11	Y-Strainer.....	11
Chimney Tee Restrictor Kit.....	22	Manifold w/o Valves.....	8		
Cinch Tool.....	6	Manifold w/Valves.....	8		
Clamp Crimp Ring Removal Tool.....	7	Manometer Kit.....	26		
Classic Stainless Steel Chimney Sections.....	22	Maxim Chimney Lengths.....	27		
Cleaning Brush.....	10	Maxim Stainless Steel Chimney Sections.....	27		
Cleaning Rod.....	20	Mixing Valves.....	13		
Combustion Fan Kit.....	25	Monofo Copper Tee.....	10		
Connector, Straight.....	15	Multi-stage 24-Volt Thermostat.....	13		
Contact Block.....	18	Natural Gas Conversion Kit.....	19		
Copper Coupling.....	14	Nipple.....	10		
Copper End Cap.....	14	O-Ring Set.....	5		
Corner Fan Convactor (7k Btu).....	3	Panel Radiators.....	9		
Corrosion Inhibitor Plus.....	16	PEX 1-1/4" Pipe.....	12		
Coupling, Reducing.....	15	PEX 90' Elbow.....	6		
Coupling, Straight.....	15	PEX Adapter.....	6		
Decoiler.....	16	PEX Adapter.....	6		
Depth Gauge/Deburring Tool.....	15	PEX Brass Clamp Fittings.....	6		
Digital Pocket Multimeter.....	26	PEX Coupling.....	6		
Digital Temperature Controller.....	18, 19	PEX Crimp Rings / Crimp Tools.....	6		
Disconnect Clip.....	15	PEX Hanger.....	7		
Diverter Tee.....	10	PEX Pipe Cutter.....	6		
Door Latch.....	26	PEX Piping Clip Gun.....	7		
Door Lock Kit.....	17	PEX Piping Clips.....	7		
Door Seal Kit.....	17, 20	PEX Piping Mounting Kit.....	7		
Door Seal Rope.....	17, 24	PEX Stainless Steel Clamp Crimp Ring.....	6		
Draft Inducer.....	17	PEX Tee.....	6		
Drain Coupling, Copper.....	14	Photoelectric Eye.....	18		

WATER-TO-AIR HEAT EXCHANGER PRODUCTS

Heat Exchanger Coil (50k Btu)

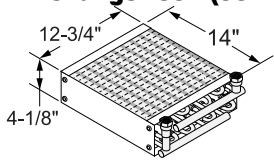

Water-to-air heat exchanger coil with 90° 3/4" female pipe thread (FPT) outlets. Dimensions: 12-3/4" x 14" x 4-1/8".

p/n	Description
287	Heat Exchanger Coil, 50k Btu

Heat Exchanger Coil (80k Btu)

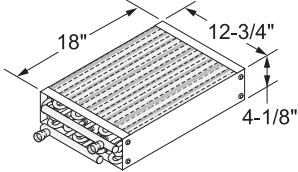

Water-to-air heat exchanger coil with straight 3/4" FPT outlets. Used in forced-air furnaces with plenum size of approximately 13" x 18". Dimensions: 12-3/4" x 18" x 4-1/8".

p/n	Description
109	Heat Exchanger Coil, 80k Btu

Heat Exchanger Coil (95k Btu)

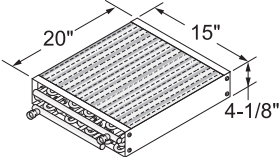

Water-to-air heat exchanger coils with straight 3/4" FPT outlets. Used in forced-air furnaces with plenum size of approximately 15" x 18". Dimensions: 15" x 20" x 4-1/8".

p/n	Description
102	Heat Exchanger Coil, Btu

Heat Exchanger Coil (100k Btu)

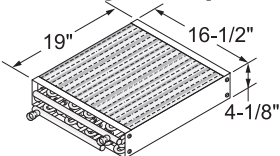

Water-to-air heat exchanger coil with straight 3/4" FPT outlets. Used in forced-air furnaces with plenum size of approximately 17" x 18". Dimensions: 16-1/2" x 19" x 4-1/8".

p/n	Description
106	Heat Exchanger Coil, 100k Btu

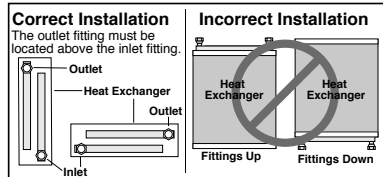

Heat Exchanger Coil (125k Btu)

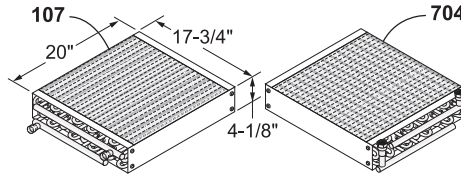

Water-to-air heat exchanger coil with straight (p/n 107) or 90-degree (p/n 704) 3/4" FPT outlets. Used in forced-air furnaces with plenum size from approximately 18" x 18" to 18" x 20". Dimensions: 17-3/4" x 20" x 4-1/8".

p/n	Description
107	Heat Exchanger Coil, 125k Btu, straight outlets
704	Heat Exchanger Coil, 125k Btu, 90° outlets

Heat Exchanger Coil (140k Btu)

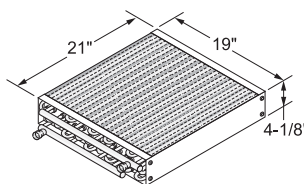

Water-to-air heat exchanger coil with straight 3/4" FPT outlets. Used in forced-air furnaces with plenum size of approximately 20" x 20". Dimensions: 19" x 21" x 4-1/8".

p/n	Description
108	Heat Exchanger Coil, 140k Btu

Heat Exchanger Coil (185k Btu)

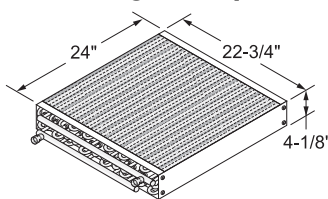

Water-to-air heat exchanger coil with straight 3/4" FPT outlets. Used in forced-air furnaces with plenum size of approximately 23" x 23". Dimensions: 22-3/4" x 24" x 4-1/8".

p/n	Description
110	Heat Exchanger Coil, 185k Btu

Heat Exchanger Coil (220k Btu)

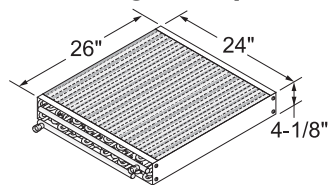

Water-to-air heat exchanger coil with straight 3/4" FPT outlets. Used in forced-air furnaces with plenum size of approximately 24" x 24". Dimensions: 24" x 26" x 4-1/8".

p/n	Description
111	Heat Exchanger Coil, 220k Btu

Suspended Space Heater (100k Btu)

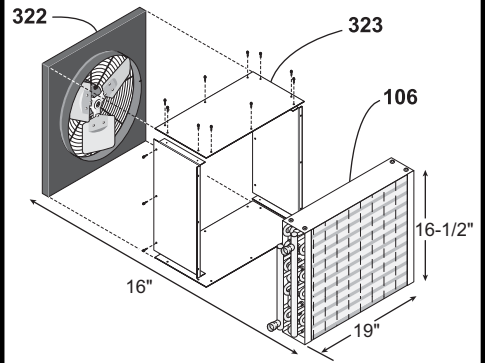

Order the following components for a complete Suspended Space Heater (100k Btu). Some assembly required. Assembled size approximately 19" x 16-1/2" x 16". Allow at least 6" on side for fittings.

p/n	Description
322	Fan
323	Transition
106	Heat Exchanger Coil, 100k Btu

Suspended Space Heater (220k Btu)

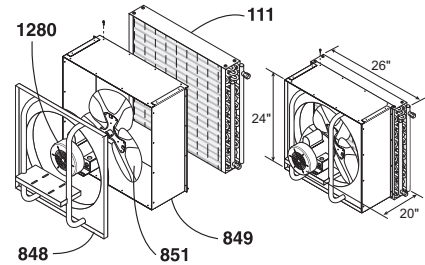

Order the following components for a complete Suspended Space Heater (220k Btu). Some assembly required. Assembled size approximately 26" x 24" x 20". Allow at least 6" on side for fittings.

p/n	Description
111	Heat Exchanger Coil, 220k Btu
849	Transition
848	Motor Frame
851	Fan Blades
1280	Fan Motor

Louvers

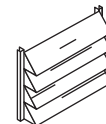

Bolt on to the face of the heat exchanger to direct heat downward.

p/n	Description
355	Louvers, fit Heat Exchanger Coil (p/n 106)
354	Louvers, fit Heat Exchanger Coil (p/n 108)
353	Louvers, fit Heat Exchanger Coil (p/n 111)

WATER-TO-AIR HEAT EXCHANGER PRODUCTS

Fan Convector (26k Btu)

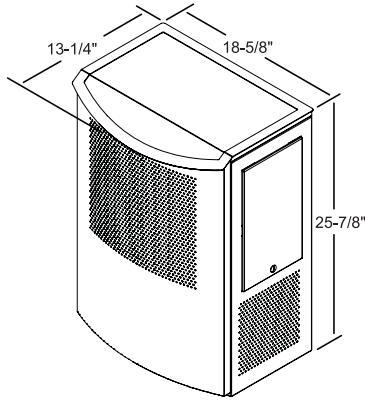

Central Boiler fan-forced convector. Quiet operation, integral filters and thermostat connections. 3/4" FPT fittings and on-off-thermostat switch. Output up to 26,000 Btu/hr. Color - taupe. 24-Volt Thermostat (p/n 588 or 8200008) is optional.

p/n	Description
1971	Fan Convector, 26k Btu
588	Programmable 24-Volt Thermostat
8200008	Non-programmable 24-Volt Thermostat
956	Elbow, 90-degree, 3/4" x 3/4" FPT (optional)

Wall Mount Fan Convector (7k Btu)

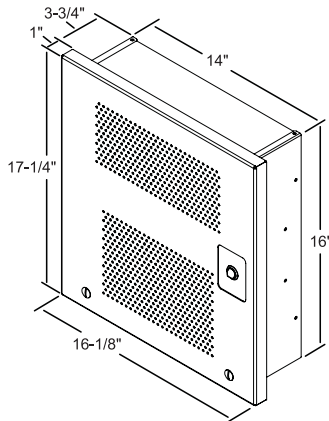

Central Boiler recessed wall, fan-forced convector. Quiet operation, integral filters and thermostat connections. Can use Female Adapter (p/n 6679) or Push-fit Fitting (p/n 606) for connection. 1/2" fittings and on-off-thermostat switch. Output up to 7,000 Btu/hr. 24-Volt Thermostat (p/n 588 or 8200008) is optional.

p/n	Description
1941	Fan Convector, Wall Mount, 7k Btu
588	Programmable 24-Volt Thermostat
8200008	Non-programmable 24-Volt Thermostat

Corner Fan Convector (7k Btu)

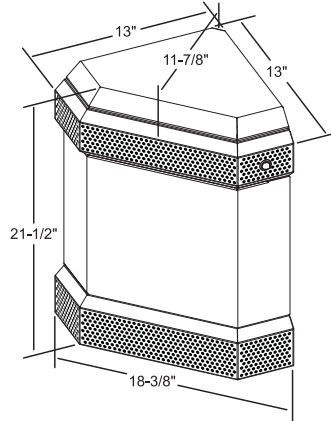

Central Boiler fan-forced convector. Quiet operation, integral filters and thermostat connections. Can use Female Adapter (p/n 6679) or Push-fit Fitting (p/n 606) for connection. 1/2" fittings and on-off-thermostat switch. Output up to 7,000 Btu/hr. 24-Volt Thermostat (p/n 588 or 8200008) is optional.

p/n	Description
1910	Fan Convector, Corner, 7k Btu
588	Programmable 24-Volt Thermostat
8200008	Non-programmable 24-Volt Thermostat

Air Filter

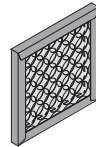

Replacement air filter (10" x 10" x 1") for fan-forced convectors. 1971 convector requires 2 filters; 1910 and 1941 convectors require 1.

p/n	Description
1938	Air Filter, 10" x 10" x 1"

Space Heater (100k Btu)

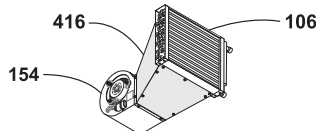

Order the following components for a Space Heater (100k Btu). Some assembly required. Assembled size approximately 19" x 21" x 33".

p/n	Description
416	Transition
154	Blower & Motor, 1/4-hp 3-speed fan
106	Heat Exchanger Coil, 100k Btu

Space Heater (140k Btu)

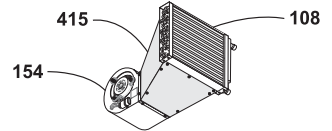

Order the following components for a Space Heater (140k Btu). Some assembly required. Assembled size approximately 19" x 21" x 33".

p/n	Description
415	Transition
154	Blower & Motor, 1/4-hp 3-speed fan
108	Heat Exchanger Coil, 140k Btu

Space Heater Cabinet (50k Btu)

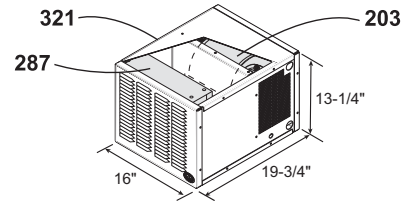

Cabinet for housing 1/15-hp Blower & Motor (p/n 203) and 50k Btu Heat Exchanger Coil (p/n 287). Each sold separately. Some assembly required. Dimensions: 16" x 19-3/4" x 13-1/4".

p/n	Description
321	Space Heater Cabinet

Blower & Motor

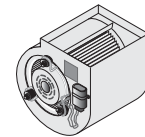

Blower & Motor assembly available in different sizes.

p/n	Description
203	Blower & Motor, 1/15-hp
154	Blower & Motor, 1/4-hp, 3-speed fan
208	Blower & Motor, 1-hp

WATER-TO-AIR HEAT EXCHANGER PRODUCTS

Air Handler Cabinet

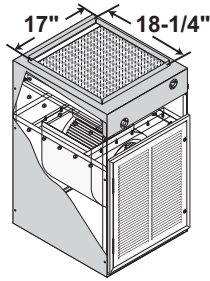

Two sizes allow multiple applications from 100k Btu to 220k Btu; cabinets are standard with front water access (refer to the chart below for specific applications). NOTE: Blower & Motor and Heat Exchanger Coil are sold separately. Air Handler Cabinet door is capable of holding a filter (not included). Some assembly will be required. If utilizing an existing 24-volt thermostat to control blower, a Fan Center Relay (p/n 515) must be used.

p/n	Dimensions (in.)	Heat Exch. Coil Range	Blower & Motor	Water Access
301	36 x 20 x 23	100k-140k Btu	1/4-hp	Front
	Filter (not included): 16 x 20			
303	39 x 25 x 28	185k-220k Btu	1-hp	Front
	Filter (not included): 20 x 20			

p/n	Description
301	Air Handler Cabinet, 100k-140k Btu, front access
3822	Kit for 301 - back water access
303	Air Handler Cabinet, 185k-220k Btu, front access
3825	Kit for 303 - back water access

Wall Mount Fan Convactor

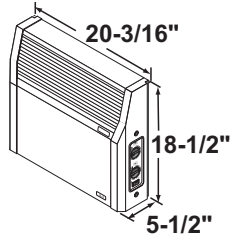

Myson Lo-Line™ RC 6-4 wall mount, fan-forced convactor with thermostat, output of 4,213-6,531 Btu/hr. Dimensions: 20-3/16" x 18-1/2" x 5-1/2". Weight: 16 lbs. Fan speed (cfm): boost - 72, medium - 51, normal - 58.

p/n	Description
6776	Myson Lo-Line RC 6-4 Fan Convactor

Wall Mount Fan Convactor

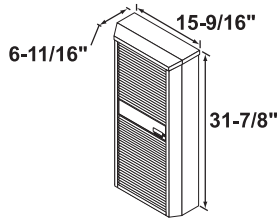

Myson Slim-Line™ RC wall mount, fan-forced convactor with remote control, output of 11,882-15,293 Btu/hr. Dimensions: 15-9/16" x 31-7/8" x 6-11/16". Weight: 37 lbs. Fan speed (cfm): boost - 136, medium - 127, normal - 96.

p/n	Description
6778	Myson Slim-Line RC Fan Convactor

Wall Mount Fan Convactor

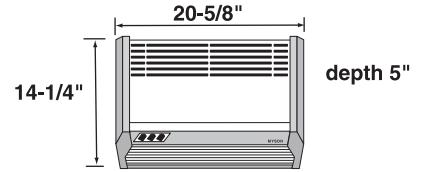

Myson Hi-Line™ HL 7-4 wall mount, fan-forced convactor, output of 4,377-7,851 Btu/hr. Dimensions: 20-5/8" x 14-1/4" x 5". Weight: 22 lbs. Fan speed (cfm): boost - 78, medium - 62, normal - 48.

p/n	Description
6777	Myson Hi-Line HL 7-4 Fan Convactor

Kickspace Fan Convactor

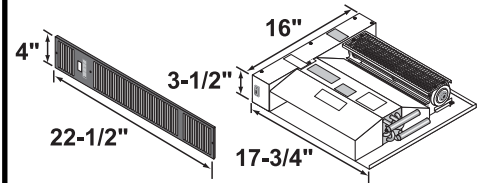

Myson Whispa™ III Kickspace 9000 fan-forced convactor, output of 7,634-9,949 Btu/hr. Dimensions: 17-3/4" x 16" x 3-1/2". Weight: 12 lbs. Fan speed (cfm): boost - 124, normal - 82. Cover grill is 4" x 22-1/2".

p/n	Description
6773	Myson Whispa II Kickspace 9000 Fan Convactor

PUMPS AND PUMP ACCESSORIES

Taco Pumps - 006 Series

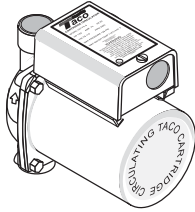

Taco 006 Bronze Circulation Pump for domestic water systems. No flange required, 3/4" sweat connection. Power Supply Cord (p/n 556) sold separately.

size	hp	Amp	Watt	Head (ft)	Volume (gal/min)
006	1/40	0.52	59.8	9	10

p/n	Description
175	Taco 006 Pump

Taco Pumps - 007 Series

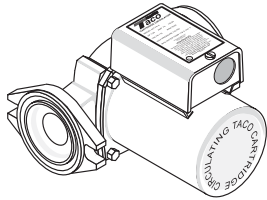

Taco 007 Circulation Pump requires flange kit (not included). Includes O-rings. Power Supply Cord (p/n 556) sold separately.

size	hp	Amp	Watt	Head (ft)	Volume (gal/min)
007	1/25	0.70	80.50	11	20
007 Priority	1/25	0.70	81.65	11	20

p/n	Description
171	Taco 007 Pump
413	Taco 007 Priority Pump

Taco Pumps - 009 & 014 Series

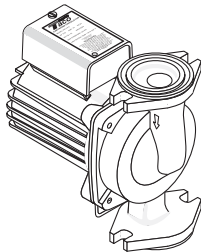

Taco 009 and Taco 014 Circulation Pumps both require flange kit (not included). Includes O-rings. Power Supply Cord (p/n 556) sold separately.

size	hp	Amp	Watt	Head (ft)	Volume (gal/min)
009	1/8	1.40	161	34	8
014	1/8	1.55	178	22	32

p/n	Description
173	Taco 009 Pump
176	Taco 014 Pump

Power Supply Cord



May be used to wire pumps when installed on furnaces. Includes strain relief.

p/n	Description
556	Power Supply Cord, 32"

O-Ring Set

Set of two replacement O-rings for pump flange.

p/n	Description
542	O-Ring Set

Taco Pump Replacement Cartridges

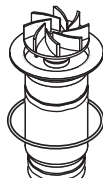

For 006 and 007 Pumps

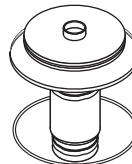

For 009 & 011 Pumps

Replacement cartridges for Taco 006, 007, 009, 011 and 014 series pumps. Each includes a 3-year warranty.

p/n	Application
222	Replacement Cartridge, 006 Series Pumps
170	Replacement Cartridge, 007 Series Pumps
172	Replacement Cartridge, 009 Series Pumps
219	Replacement Cartridge, 011 Series Pumps
179	Replacement Cartridge, 014 Series Pumps

Isolation Flange Kit

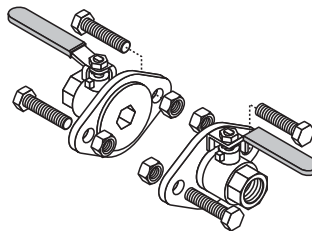

Kit includes flanges, nuts and bolts. Full port, valved flange body.

p/n	Description
224	"Free Floating" Flange Kit, 3/4"
225	Isolation Flange Kit, 1-1/4"

Isolation Flange with Drain Valve, 3/4"

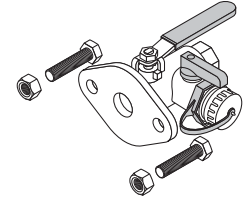

Includes flange, nuts and bolts.

p/n	Description
226	Isolation Flange with Drain Valve, 3/4"

Pump Flange Kits

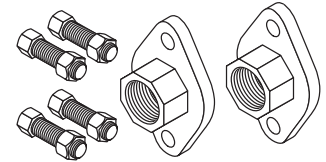

Each kit includes set of two female iron pipe (FIP) pump flanges. One set is used with each pump. Most installations use Pump Flange Kit, 3/4" (p/n 119).

p/n	Description
119	Pump Flange Kit, 3/4"
194	Pump Flange Kit, 1"
1272	Pump Flange Kit, 1-1/4"

Pump Wall Mount Kit

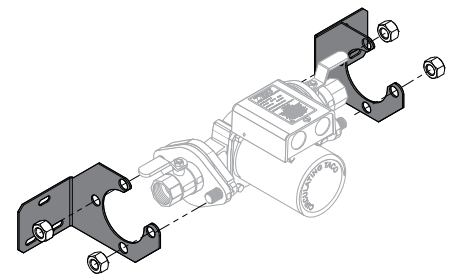

Brackets for supporting and securing Taco pump and flanges to a wall. Figure shows one possible installation scenario. Pump, flanges and mounting hardware are not included.

p/n	Description
1366	Pump Wall Mount Kit

PEX PIPE, FITTINGS AND RELATED

Central PEX 1/2" Pipe

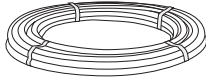

High-density, oxygen barrier, cross-link pipe. Rated for temperatures to 180°F at 100 psi. Available in rolls up to 1000 ft long. Excellent for radiant floor heating applications.

p/n	Description
1320	Central PEX 1/2" Pipe, 300'
1321	Central PEX 1/2" Pipe, 500'
1322	Central PEX 1/2" Pipe, 1000'

Central PEX 1" Pipe

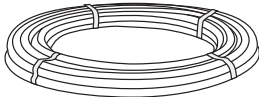

High-density, cross-link pipe, rated for temperatures to 180°F at 100 psi.

p/n	Description
1311	Central PEX 1" Pipe, 100'
1312	Central PEX 1" Pipe, 200'
1313	Central PEX 1" Pipe, 300'
1314	Central PEX 1" Pipe, 500'

Central PEX 1" Pipe Sections

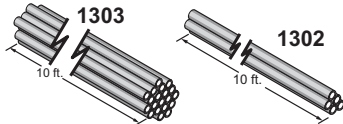

Central PEX 1" Pipe in 10-ft sections.

p/n	Description
1302	Central PEX 1" Pipe, 10' straight section, 5 per bag
1303	Central PEX 1" Pipe, 10' straight section, 20 per bag

PEX Pipe Cutter

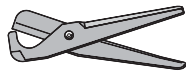

Used to cut PEX pipe up to 1-1/4" in diameter.

p/n	Description
195	PEX Pipe Cutter

PEX Brass Clamp Fittings

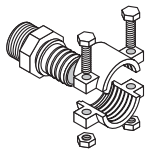

Brass adapter clamps for PEX pipe.

p/n	Description
5642	Brass Clamp Fittings, 1"
5643	Brass Clamp Fittings, 1-1/4"

PEX Coupling



For coupling two Central PEX pipe ends.

p/n	Description
1339	PEX Coupling, 1/2"
1333	PEX Coupling, 1"

PEX Adapter

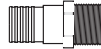

For adapting threaded pipe to Central PEX pipe.

p/n	Description
1341	PEX Adapter, 1/2" PEX x 1/2" MIP fittings
1336	PEX Adapter, 1/2" PEX x 3/4" MIP fittings
1330	PEX Adapter, 1" PEX x 3/4" MIP fittings
1324	PEX Adapter, 1" PEX x 1" MIP fittings

PEX Adapter



For adapting copper pipe to Central PEX pipe.

p/n	Description
1337	PEX Adapter, 1/2" PEX x 1/2" sweat fittings
1331	PEX Adapter, 1" PEX x 1" sweat fittings
1348	PEX Adapter, 1/2" PEX x 1/2" FIP fittings

Female Adapter



Adapts 1/2" copper pipe to 1/2" Central PEX pipe. Sweat end fits over copper pipe.

p/n	Description
6679	Female Adapter, 1/2" barb x 1/2" sweat fittings

PEX 90° Elbow



For coupling two Central PEX pipe ends together.

p/n	Description
1340	PEX 90° Elbow, Brass, 1/2"
1334	PEX 90° Elbow, Brass, 1"

PEX Tee



Brass tee for joining Central PEX pipe ends.

p/n	Description
1338	PEX Tee, 1/2"
1332	PEX Tee, 1"

Central Boiler Clamp



1" or 1-1/4" stainless steel hose clamp.

p/n	Description
5978	Central Boiler Clamp, 1"
1745	Central Boiler Clamp, 1-1/4"

Cinch Tool

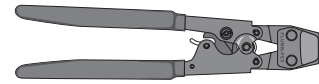

Tool for cinching 1" and 1/2" PEX Stainless Steel Clamp Crimp Rings to PEX pipe. Not for use with any other application.

p/n	Description
5925	Cinch Tool

PEX Crimp Rings / Crimp Tools



PEX Crimp Ring for PEX pipe. Crimp Tool (p/n 324) required for 1/2" crimp ring. Crimp Tool (p/n 145) required for 1" crimp ring.

p/n	Description
1342	PEX Crimp Ring, 1/2"
1335	PEX Crimp Ring, 1"
324	Crimp Ring Tool, 1/2"
145	Crimp Ring Tool, 1"

Ratchet Cinch Tool

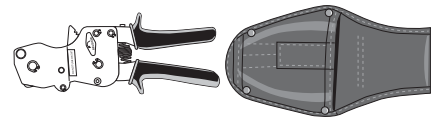

Compact, easy-to-use Ratchet Cinch Tool comes with handy carrying case and calibrating device. For use with 5927 and 5926 crimp rings.

p/n	Description
4472	Ratchet Cinch Tool

PEX Stainless Steel Clamp Crimp Ring



For use with Central PEX pipe. Install with Cinch Tool (p/n 5925) or Ratchet Cinch Tool (p/n 4472).

p/n	Description
5927	PEX Stainless Steel Clamp Crimp Ring, 1/2"
5926	PEX Stainless Steel Clamp Crimp Ring, 1"

PEX PIPE RELATED, THERMOPEX AND CENTRAL THERM

Clamp Crimp Ring Removal Tool

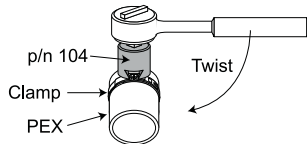

Used to remove PEX stainless steel clamp crimp rings (p/n 5927 and 5926).

p/n	Description
104	Clamp Crimp Ring Removal Tool

PEX Piping Mounting Kit

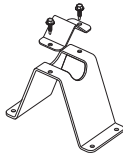

Used to secure 1" PEX or copper pipe. Includes base, top bracket and two screws.

p/n	Description
1360	PEX Piping Mounting Kit

PEX Piping Clip Gun

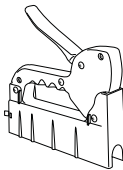

Used to secure 1/2" PEX pipe. Clips sold separately.

p/n	Description
2900002	PEX Piping Clip Gun

PEX Piping Clips

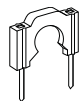

Clips used in PEX Piping Clip Gun (p/n 2900002). Qty. 100.

p/n	Description
2900003	PEX Piping Clips, 100 qty.

PEX Hanger

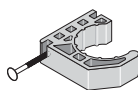

Half-moon, nail-in PEX Hanger for securing PEX piping. Available in two sizes.

p/n	Description
293	PEX Hanger, 1/2"
295	PEX Hanger, 1"

ThermoPEX



ThermoPEX is flexible pre-insulated piping consisting of two waterproof oxygen barrier PEX lines (supply and return) protected by polyurethane closed cell foam insulation and a thick, durable, waterproof polyethylene outer jacket. It is the ideal insulated piping for use with outdoor wood furnaces. Available with 1" Central PEX in 100-ft or 800-ft rolls, or with 1-1/4" PEX in 100-ft or 300-ft rolls.

p/n	Description
2441	ThermoPEX, 1", 100' Roll
2491	ThermoPEX, 1", 800' Roll
2799	ThermoPEX, 1-1/4", 100' Roll
2492	ThermoPEX, 1-1/4", 300' Roll

ThermoPEX Termination Cap



Fits snugly over each end to protect and seal the insulation from water.

p/n	Description
2443	ThermoPEX Cap, 1"
2494	ThermoPEX Cap, 1-1/4"

ThermoPEX Coupling Kit

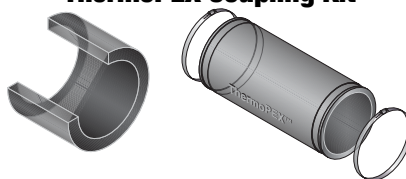

Twelve-inch rubber splice is used to join two ends of ThermoPEX together. Fittings and crimp rings for joining the PEX lines are sold separately.

p/n	Description
2447	ThermoPEX Coupling Kit, 1"
2495	ThermoPEX Coupling Kit, 1-1/4"
1333	PEX Coupling, 1"
381	Brass Coupling, 1-1/4" barb x 1-1/4" barb

Central Therm Insulation

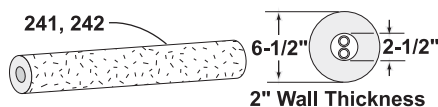

Closed-cell, green polyethylene Central Therm Insulation for insulating water lines. Available in either 8-ft or 4-ft lengths.

p/n	Description
241	Central Therm Insulation, 8'
242	Central Therm Insulation, 4'

Central Therm Sleeve



Slips over Central Therm Insulation to keep it dry and increase heat transfer efficiency, especially in the spring when ground water is high. Available in lengths from 100 to 800 feet.

p/n	Description
524	Central Therm Sleeve, 100'
525	Central Therm Sleeve, 200'
526	Central Therm Sleeve, 300'
527	Central Therm Sleeve, 500'
672	Central Therm Sleeve, 800'

Central Therm Sleeve Dispenser

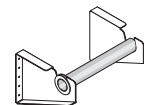

Handy dispenser holds all roll lengths of Central Therm Sleeve.

p/n	Description
506	Central Therm Sleeve Dispenser

MANIFOLDS AND WATER-TO-WATER EXCHANGERS

Manifold w/Valves

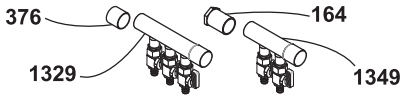

For use with 1/2" PEX pipe in radiant floor installations. Available in a 2- or 3-loop configuration. Manifold fittings are 1" copper sweat; valve fittings are 1/2" barbed.

p/n	Description
1349	Manifold w/Valves, 2-Loop
1329	Manifold w/Valves, 3-Loop
376	Copper Cap, 1"

Manifold w/o Valves



For use with 1/2" PEX pipe in radiant floor installations. Available in a 2- or 3-loop configuration. Manifold fittings are 1" copper sweat; valve fittings are 1/2" barbed. Does not include valves or caps.

p/n	Description
1880	Manifold w/o Valves, 2-Loop
1885	Manifold w/o Valves, 3-Loop

Plate Heat Exchanger

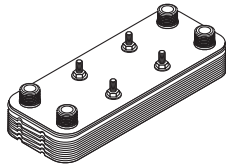

The Plate Heat Exchanger is a compact, high-performance, water-to-water, continuous flow heat exchanger with MPT ports. Units are 316L stainless, copper-brazed. MPN units include mounting studs and are marine-grade stainless, nickel-brazed (for use with pools and hot tubs).

p/n	Typical Application
5734	Water heaters
5744	Boilers up to 100k Btu
5636	Boilers 100k-175k Btu
5637	Boilers 175k-250k Btu
5635	Large commercial

p/n	Description
5734	Plate Exchanger, 5 x 12-6, 3/4" Port
5744	Plate Exchanger, 5 x 12-30, 1" Port
5636	Plate Exchanger, 5 x 12-50, 1-1/4" Port
5637	Plate Exchanger, 5 x 12-70, 1-1/4" Port
5634	Plate Exchanger, 10 x 20-40, 1-1/2" Port
5635	Plate Exchanger, 10 x 20-50, 2" Port

MPN Units*

p/n	Approximate Btu	Typical Application
5738	80-120k	Hot tubs & pools up to 12,000 gallons
5842	150-200k	Pools up to approx. 30,000 gallons
128	250-320k	Pools up to approx. 50,000 gallons
129	280-360k	Pools up to approx. 60,000 gallons

p/n	Description
5738	Plate Exchanger, MPN 5 x 12-10, 1" Port
5842	Plate Exchanger, MPN 5 x 12-24, 1-1/4" Port
128	Plate Exchanger, MPN 5 x 12-40, 1-1/4" Port
129	Plate Exchanger, MPN 5 x 12-50, 1-1/4" Port

*MPN units are not recommended for use with salt chlorinated pools or hot tubs.

Plate Mounting Bracket



Used to mount most 5" x 12" Plate Heat Exchangers (30 or less) with mounting studs to a wall or similar surface.

p/n	Description
5807-011	Plate Mounting Bracket

Heat Exchanger Mounting Kit

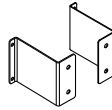

Used to mount most 5x12 Plate Heat Exchangers (40 or more) with mounting studs to a wall or similar surface. Includes two mounting brackets.

p/n	Description
9597	Heat Exchanger Mounting Kit

Universal Heat Exchanger Mounting Kit

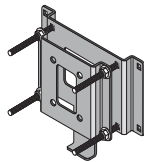

p/n	Description
1097	Universal Heat Exchanger Mounting Kit

Flow Check Valve

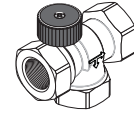

Used in hydronic heating to prevent ghost flow when the components are above the manifold. Can be installed horizontally or vertically.

p/n	Description
201	Flow Check Valve, 1" threaded

Fittings Kit, Threaded

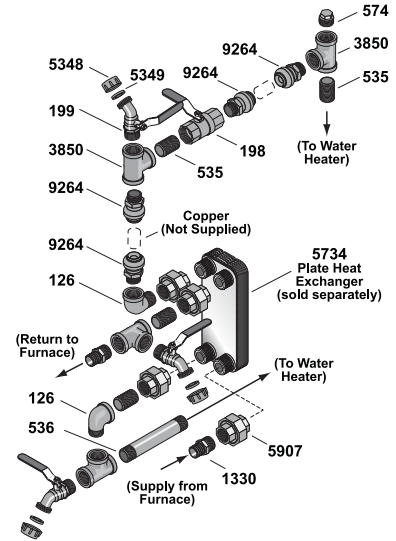

For domestic water heaters using Plate Heat Exchanger (p/n 5734).

p/n	Description
2500013	Fittings Kit, threaded ports

Water-to-Water Heat Exchanger, Double Wall

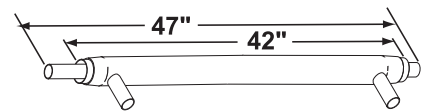

The Water-to-Water, Double Wall Heat Exchanger is a water-to-water, domestic water heat exchanger with 3/4" copper sweat ports. Install on existing water heater for thermal circulating heat transfer.

p/n	Description
318	Heat Exchanger, Water-to-Water, Double Wall, 42"

WATER-TO-WATER EXCHANGERS

Water-to-Water Heat Exchanger, Shell & Tube

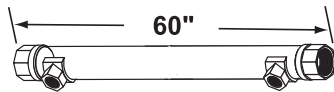

A water-to-water, continuous-flow heat exchanger used mainly for boiler applications. Side ports are 3/4" FIP; end ports are 1-1/2" FIP.

p/n	Description
151	Water-to-Water Heat Exchanger, Shell & Tube, 60"

Water-to-Water Heat Exchanger, Shell & Tube

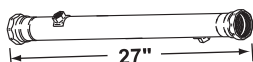

A water-to-water, continuous-flow heat exchanger for commercial water heater applications. Side ports are 3/4" FIP; end ports are 1-1/2" FIP.

p/n	Description
148	Water-to-Water Heat Exchanger, Shell & Tube, 27"

Water-to-Water Heat Exchanger, Shell & Tube

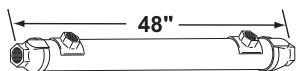

A water-to-water, continuous-flow heat exchanger used mainly for boiler applications. Side ports are 1" FIP; end ports are 1-1/2" FIP.

p/n	Description
177	Heat Exchanger, Water-to-Water, Shell & Tube, 48"

Always use the Shell & Tube Heat Exchangers (p/n 148, 151 or 177) when heating "salt chlorinated" pools and hot tubs. Install Plate Heat Exchangers (MPN units) for standard chlorinated pools and hot tubs. See your dealer for more information.

Water-to-Water Heat Exchanger & Fittings Kit

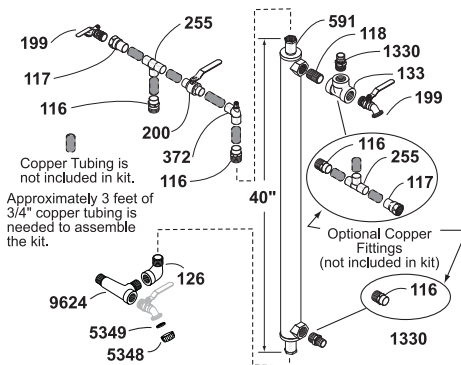

Copper Tubing is not included in kit. Approximately 3 feet of 3/4" copper tubing is needed to assemble the kit.

p/n	Description
591	Water-to-Water Heat Exchanger, 40"
2053	Fittings Kit

Automatic Vent Valve



Vents air automatically. For use in pressurized systems only. Fitting is 1/8" NPT.

p/n	Description
286	Automatic Vent Valve

Panel Radiators

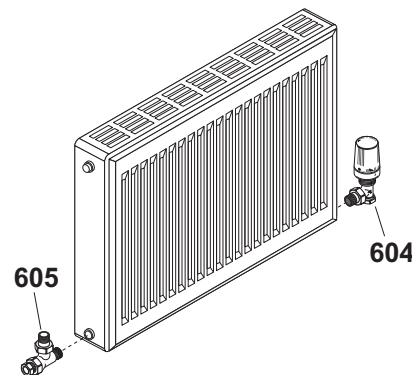

Type 21G Double Panel Single Convactor and Type 22G Double Convactor panel radiators in various sizes and Btu output. Valves (p/n 604, 605 are sold separately).

p/n	Baseboard Equivalent	Output (Btu/hr)	Fan Convactor Equivalent
600	6 feet	3,100	N/A
601	10 feet	5,000	6777, 6774, 6839
602	14 feet	7,200	6776, 6780
603	18 feet	10,000	6779, 6773

- No electricity required, no thermostats, no extra pumps
- Easy installation - includes mounting bracket and thread sealer

p/n	Description
600	Panel Radiator, 32" x 16"
601	Panel Radiator, 35-1/2" x 24"
602	Panel Radiator, 51-1/2" x 24"
603	Panel Radiator, 55-1/4" x 24"

Thermostatic Radiator Valves

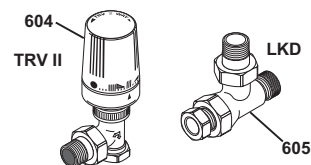

Each valve body is threaded for nominal iron pipe threads and also comes with a compression nut and ferrule.

p/n	Description
604	TRV II Valve Body and Head, 1/2" Vertical
605	LKD Valve Body with No Cap, 1/2" Preset Flow Rate

CONNECTIONS, SOLDER AND FLUX

Solder & Soldering Flux



Low melting-point solder for easier soldering. Soldering flux includes brush. Use for easier soldering of copper sweat fittings.

p/n	Description
1325	Solder
100	Soldering Flux (6 oz)

Cleaning Brush



For cleaning the inside of copper fittings.

p/n	Description
378	Cleaning Brush, 3/4"
379	Cleaning Brush, 1"

Hex Bushing



Hex bushing with national pipe threads (NPT).

p/n	Description
388	Hex Bushing, 1-1/4" x 3/4"
105	Hex Bushing, 1-1/2" x 3/4"
412	Hex Bushing, 1-1/4" x 1/2"
325	Hex Bushing, 3/4" x 1/2"
180	Hex Bushing, 3/4" x 1/8"
408	Hex Bushing, 1-1/2" x 1-1/4"

Brass Hex Bushing



Brass NPT reducing bushing.

p/n	Description
385	Brass Hex Bushing, 1-1/2" x 3/4"
3851	Brass Hex Bushing, 1-1/4" x 3/4"
3042	Brass Hex Bushing, 1/2" x 1/8"

Brass Pipe Union, FIP



Suggested for use with plate-style heat exchanger installations.

p/n	Description
5907	Brass Pipe Union, 3/4"
5908	Brass Pipe Union, 1"
5909	Brass Pipe Union, 1-1/4"

Pipe Plug



Pipe Plug, MPT, black, unless noted.

p/n	Description
331	Pipe Plug, 3/4"
574	Pipe Plug, Brass 3/4"
336	Pipe Plug, 1-1/2"
383	Pipe Plug, 1-1/4"
6557	Pipe Plug, Brass 1/2"

Pipe Plug Wrench Set

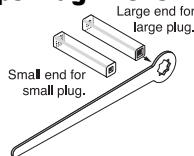

Used to remove and install 1-1/4" and 3/4" pipe plugs. Large end is for 1-1/4"; small end fits 3/4" pipe plugs.

p/n	Description
5459	Pipe Plug Wrench Set

Nipple



Extra-heavy male pipe thread (MPT) nipples. Nipple (p/n 118) is used with pumps and ball valves. Brass nipples must be used on stainless steel furnaces.

p/n	Description
118	Nipple, 3/4" x close
409	Nipple, 1-1/4" x close
314	Nipple, 1-1/2" x close
533	Nipple, 3/4" x 2"
534	Nipple, 3/4" x 7"
535	Nipple, Brass, 3/4" x 2"
536	Nipple, Brass, 3/4" x 7"
11157	Nipple, Schedule 80, Black, 1-1/4" x 3"
5000015	Nipple, Schedule 80, Black, 1-1/4" x 2-1/2"

Brass Hose Bib



Brass hose bib, 3/4" MPT. Use brass cap (p/n 5348) with washer (p/n 5349) to cover end.

p/n	Description
199	Brass Hose Bib, 3/4" MPT
5349	Washer, 3/4"
5348	Cap, Brass, 3/4"

Tee



Black Tee (p/n 133) can be used for vent option near pump. Brass Tee (p/n 3850) can be used in domestic water situations. Black Tee (p/n 418) can be used to install 1-1/4" thermostatic valve.

p/n	Description
133	Tee, Black, 3/4" NPT
3850	Tee, Brass, 3/4" NPT
418	Tee, Black, 1-1/4" NPT

Brass Tee, 3/4"



Brass Tee, 3/4" male x female x male. Mainly used for installing heat exchanger on water heater when push-fit fittings are used.

p/n	Description
9624	Tee, Brass, 3/4"

Brass Offset Tee, 4"



Can be used in conjunction with the Temperature Gauge (p/n 174 or p/n 6054) for monitoring furnace supply water temperature, or may be used instead of Nipple (p/n 533) and 90° Street Elbow (p/n 274) on supply and/or return bung.

p/n	Description
6764	Brass Offset Tee, 4"

Diverter Tee

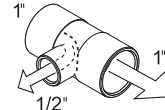

The diverter tee is an excellent sweat fitting used mainly with fan-forced heaters.

p/n	Description
6782	Diverter Tee, 1" x 1" x 1/2"

Monoflo Copper Tee

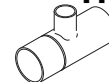

Used to divert water into fan-forced heaters and radiators.

p/n	Description
4976	Copper Tee, 1" x 1" x 1/2"

45° Street Elbow



NPT 45° Street Elbow (black).

p/n	Description
124	45° Street Elbow, 3/4"
5000017	45° Street Elbow, 1-1/4"

90° Street Elbow



90° Street Elbow in different sizes.

p/n	Description
411	90° Street Elbow, 1-1/4"
274	90° Street Elbow, 3/4"
126	90° Street Elbow, Brass, 3/4"

90° Elbow



90° Elbow with female threads.

p/n	Description
956	90° Elbow, 3/4" x 3/4" FPT
5000016	90° Elbow, Black, 1-1/4"

VALVES, MANIFOLDS, STRAINERS, CONNECTIONS, ADAPTERS

Ball Valve

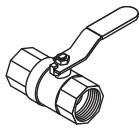

Brass FIP Ball Valve. The 3/4" Full Port Ball Valve (p/n 198) is used on both sides of the pump and on the furnace for each water line.

p/n	Description
186	Ball Valve, 1/2"
198	Ball Valve, 3/4" Full Port
410	Ball Valve, 1-1/4"

3/4" Thermostatic Valve Kit

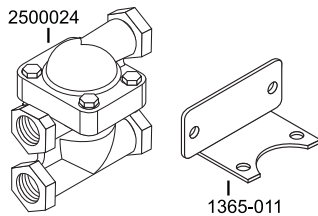

Thermostatic Valve prevents the water temperature from dropping below the optimal operating temperature.

p/n	Description
2500024	3/4" NPT Thermostatic Valve Kit
1365-011	Mounting Bracket for 3/4" NPT Thermostatic Valve

3/4" Thermostatic Valve Fittings Kit

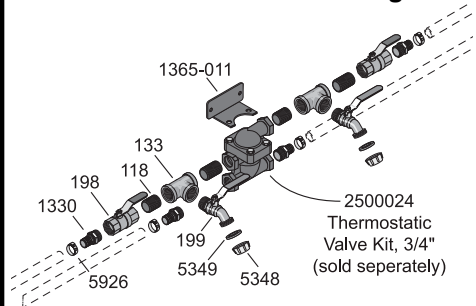

For 3/4" Thermostatic Valve (p/n 2500024).

p/n	Description
1548	3/4" NPT Thermostatic Valve Fittings Kit

1-1/4" Thermostatic Valve

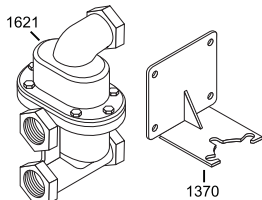

Thermostatic Valve prevents the water temperature from dropping below the optimal operating temperature.

p/n	Description
1621	1-1/4" NPT Thermostatic Valve
1370-011	Mounting Bracket for 1-1/4" NPT Thermostatic Valve

1-1/4" Thermostatic Valve Fittings Kit

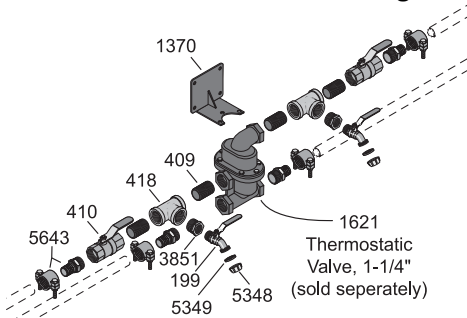

For 1-1/4" Thermostatic Valve (p/n 1621).

p/n	Description
1624	1-1/4" NPT Thermostatic Valve Fittings Kit

3-Way Valve

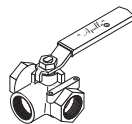

Manually operated, FIP, brass 3-Way Valve.

p/n	Description
330	3-Way Valve, Brass 3/4" FIP

Brass Swing Check Valve



Brass Swing Check Valve with FIP fittings prevents reverse circulation.

p/n	Description
296	Brass Swing Check Valve, 3/4"
5871	Brass Swing Check Valve, 1-1/4"

Cast Iron Manifold



Cast Iron Manifold features 1-1/2" FIP inlet and four 3/4" FIP outlets.

p/n	Description
407	Cast Iron Manifold

Manifold

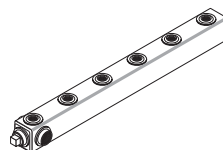

Manifold features two 1-1/4" fittings, six 3/4" FIP fittings and two 1-1/4" bungs (one at each end) for large building system. Manifold measures 3" x 3" x 33-1/2".

p/n	Description
395	Manifold

Manifold

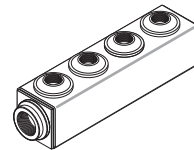

Manifold features 1-1/4" inlet and four 3/4" outlets. Manifold measures 3-1/4" x 3-1/4" x 12-1/4".

p/n	Description
1200033-011	Manifold, 1-1/4" Inlet x (4) 3/4" Outlets

Manifold

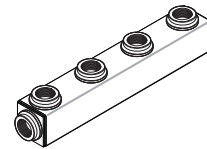

Manifold features 1-1/4" inlet and four 1-1/4" outlets. Manifold measures 3-1/4" x 3-1/4" x 19".

p/n	Description
1200034-011	Manifold, 1-1/4" Inlet x (4) 1-1/4" Outlets

Y-Strainer

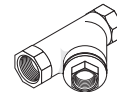

Y-Strainer with 0.20 mesh and FIP fittings. Recommended when installing plate-style heat exchangers. For 3/4" Y-Strainer, use 1/2" Brass Pipe Plug (p/n 6557) for cleanout port. For 1" Y-Strainer, use 3/4" Brass Pipe Plug (p/n 574) for cleanout port.

p/n	Description
1695	Y-Strainer, 3/4" Brass
573	Y-Strainer, 1" Brass
1694	Y-Strainer, 1-1/4" Black

Hot Filter & Cartridge

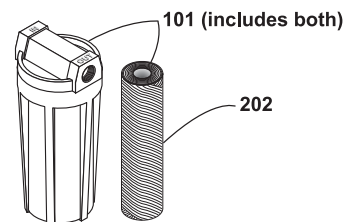

Hot Filter (#10) with cartridge, 3/4" FIP fittings.

p/n	Description
101	Hot Filter, 3/4" FIP
202	Cartridge, #10

VALVES, MANIFOLDS, STRAINERS, CONNECTIONS, ADAPTERS

Brass Coupling



Brass Coupling with 3/4" threaded fittings.

p/n	Description
5367	Brass Coupling, 3/4" thread

Backflow Preventer

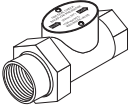

Used to protect water supplies from contamination.

p/n	Description
8364	Backflow Preventer, 3/4"

Purging and Filling Tee

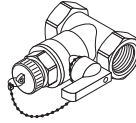

Used to fill system and purge system of air.

p/n	Description
134	Purging and Filling Tee, 1"

Female Adapter, 3/4" Hose



p/n	Description
4928	Brass Adapter, 3/4" female hose x 3/4" male pipe

Male Adapter, 3/4" Hose



p/n	Description
4929	Brass Adapter, 3/4" male hose x 3/4" male pipe

Brass Fittings for 1-1/4" PEX Pipe

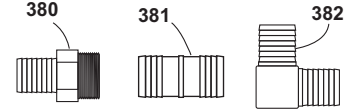

Brass fittings for 1-1/4" PEX pipe. To ease installation, it is recommended that a heat gun be used on the 1-1/4" PEX pipe.

p/n	Description
380	Male Adapter, 1-1/4" barb x 1-1/4" MIP
381	Brass Coupling, 1-1/4" barb x 1-1/4" barb
382	Brass Elbow, 1-1/4" barb x 1-1/4" barb

PEX 1-1/4" Pipe

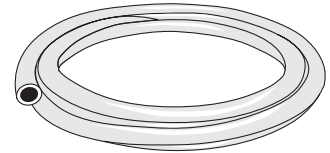

High-density, oxygen barrier, cross-link pipe, rated for 180°F. Each length should be insulated separately as two will not fit inside Central Therm insulation.

p/n	Description
5670	PEX 1-1/4" Pipe, 150'
386	PEX 1-1/4" Pipe, 300'

THERMOSTATS, TRANSFORMERS, AQUASTATS

Line Voltage Thermostat



Line Voltage Thermostat (120-volt) used to start the fan on forced-air systems.

p/n	Description
1267	Line Voltage Thermostat

Programmable 24-Volt Thermostat



Can be used in conjunction with zone valves, zone pumps and forced-air systems or used to operate 24-volt 3-way zone valves (requires 24-volt transformer).

p/n	Description
588	Programmable 24-Volt Thermostat

Single-stage, Non-programmable 24-Volt Thermostat



Can be used in conjunction with zone valves, zone pumps and forced-air systems or used to operate 24-volt 3-way zone valves (requires 24-volt transformer).

p/n	Description
8200008	Non-programmable 24-Volt Thermostat

Multi-stage 24-Volt Thermostat

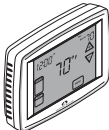

Large, easy-to-read screen allows homeowners to use one thermostat to control up to three stages of heat and two stages of cooling. Fully programmable. Must be installed and wired by a qualified service technician.

p/n	Description
587	Multi-stage 24-Volt Thermostat

Plug-in Thermostat

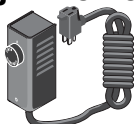

Plug-in Thermostat, 13.5-amp rated, 110-Volt, is for operating fan.

p/n	Description
368	Plug-in Thermostat

24-Volt Transformer

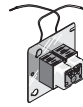

Used with 24-volt wall thermostat and 24-volt zone valves.

p/n	Description
188	24-Volt Transformer

3-Way Zone Valve, 24-Volt

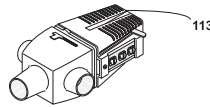

Used to bypass water for radiant floor heat, baseboard heat, swimming pool heaters, etc. (requires 24-volt transformer).

p/n	Description
114	3-Way Zone Valve, 24-Volt, 1" sweat fittings
127	3-Way Zone Valve, 24-Volt, 3/4" sweat fittings
113	Replacement Head

2-Way Zone Valve, 24-Volt

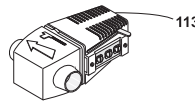

Used to bypass water for radiant floor heat, baseboard heat, swimming pool heaters, etc. (requires 24-volt transformer).

p/n	Description
671	2-Way Zone Valve, 24-Volt, 1" sweat fittings
571	2-Way Zone Valve, 24-Volt, 3/4" sweat fittings
113	Replacement Head

Tempering Valve



Mixing valve for tempering hot water, with an adjustable temperature range between 120-160°F.

p/n	Description
163	Tempering Valve, 1/2" sweat fittings
140	Tempering Valve, 3/4" sweat fittings

Radiant Mixing Valve



For controlling water temperature in various types of radiant heat systems. Temperature range 70°F -180°F (except p/n 306, range 70°F - 145°F). These are not anti-scald valves and are not intended to be used on water heaters.

p/n	Description
306	Radiant Mixing Valve, 1/2" NPT fittings
327	Radiant Mixing Valve, 3/4" NPT fittings
329	Radiant Mixing Valve, 1" NPT fittings

Water Heater Mixing Valve



Designed specifically for water heaters, with a temperature range of 90°F - 130°F.

p/n	Description
326	Water Heater Mixing Valve, 3/4" NPT fittings
620	Water Heater Mixing Valve, Low Lead, 3/4" sweat fittings*

*Required in CA, VT and MD.

Pool Aquastat

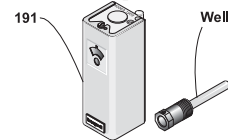

For controlling water temperature in pools, spas, etc., Immersible, temperature range of 40-180°F in one-degree differential. With pool or hot tub application, it is recommended to use a stainless steel well (p/n 1248), sold separately.

p/n	Description
191	Pool Aquastat, 1/2" NPT fitting
1247	Well, 1/2" NPT fitting
1248	Well, SS, 1/2" NPT fitting

Adjustable Aquastat, Immersible

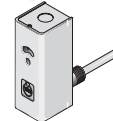

Adjustable between 110-240°F, immersible, with 1/2" MPT fittings on well (either close on rise or open on rise). Recommended operating setting is between 165-195°F.

p/n	Description
169	Adjustable Aquastat

Adjustable Aquastat, Surface Mount

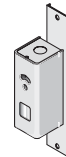

For 1992 and older Classic outdoor wood furnaces, adjustable from 100-240°F.

p/n	Description
204	Adjustable Aquastat

Fixed Aquastat, 175°F



Non-adjustable, immersible, 1/2" MPT fitting.

p/n	Description
290	Fixed Aquastat, 175°F

BASEBOARDS, COPPER CONNECTIONS

Baseboard Joiner



Used to cover joints in continuous lengths of baseboard.

p/n	Description
230	Baseboard Joiner

Baseboard, Complete

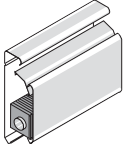

Each baseboard includes heating element and cover. Rated 610 Btu/ft at 180°F water temperature. Flow rate of 4 gal/min, 3/4" copper sweat fittings. End caps, joiners and corners sold separately.

p/n	Description
234	Baseboard, Complete, 2'
235	Baseboard, Complete, 3'
236	Baseboard, Complete, 4'
237	Baseboard, Complete, 5'
238	Baseboard, Complete, 6'

Baseboard End Cap

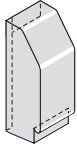

Left or right Baseboard End Caps for radiant baseboard water heater.

p/n	Description
232	Baseboard End Cap, Left
233	Baseboard End Cap, Right

Baseboard Corners

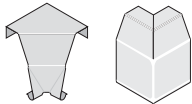

Inside and outside Baseboard Corner covers for radiant baseboard water heater.

p/n	Description
182	Baseboard Corner, Inside
183	Baseboard Corner, Outside

90° Street Elbow, 1" Copper



90° street elbow with 1" female sweat fitting on one end and 1" male sweat fitting on the other.

p/n	Description
103	Street Elbow, 1"

Copper Coupling

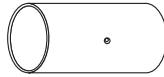

p/n	Description
146	Copper Coupling, 3/4" sweat x 3/4" sweat fittings
147	Copper Coupling, 1" sweat x 1" sweat fittings

Male Adapter, Copper

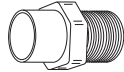

p/n	Description
116	Male Adapter, 3/4" sweat x 3/4" MIP fittings
120	Male Adapter, 1" sweat x 1" MPT fittings

Female Adapter, Copper

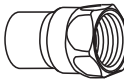

p/n	Description
164	Female Adapter, 1" sweat x 3/4" FIP fittings
117	Female Adapter, 3/4" sweat x 3/4" FIP fittings

Tee, Copper

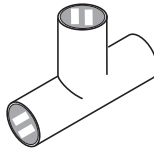

p/n	Description
138	Tee, Copper Pipe, 1" x 1" x 1" sweat fittings
255	Tee, Copper Pipe, 3/4" x 3/4" x 3/4" sweat fittings

Reducing Tee, Copper



p/n	Description
178	Reducing Tee, 1-1/2" x 1" x 1" sweat fittings

Copper End Cap



p/n	Description
376	Copper End Cap, 1" sweat fitting

Vent Elbow, Copper

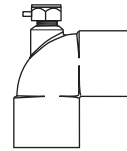

p/n	Description
372	Vent Elbow, 3/4" x 3/4" sweat fittings
112	Vent Elbow, 1" x 1" sweat fittings

Drain Coupling, Copper

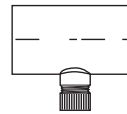

p/n	Description
373	Drain Coupling, Copper Pipe, 3/4" x 3/4" sweat fittings

Reducer, Copper

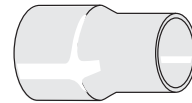

p/n	Description
231	Reducer, Copper Pipe, 1" x 3/4" sweat fittings

90° Reducing Elbow, Copper

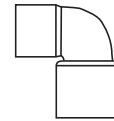

p/n	Description
123	90° Reducing Elbow, Copper Pipe, 1" x 3/4" sweat fittings

90° Elbow, Copper

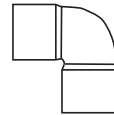

p/n	Description
276	90° Elbow, Copper Pipe, 3/4" x 3/4" sweat fittings
277	90° Elbow, Copper Pipe, 1" x 1" sweat fittings

Sweat Ball Valve

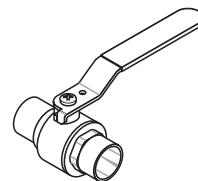

p/n	Description
200	Sweat Ball Valve, 3/4" x 3/4" sweat fittings

PUSH-FIT FITTINGS

Push-fit Fittings

Push-fit Fittings are designed to simplify pipe installation. The fittings allow the user to connect pipe in seconds with relative ease.

- Instant push-fit connection for increased ease-of-use.
- No soldering, clamps, unions or glue required.
- Fits copper tubing and PEX piping and connects in any combination.

Coupling, Straight

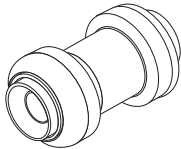

p/n 606 Description Coupling, Straight, 1/2" x 1/2"
 p/n 607 Description Coupling, Straight, 3/4" x 3/4"
 p/n 608 Description Coupling, Straight, 1" x 1"

Coupling, Reducing

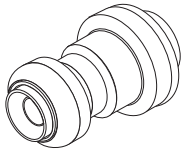

p/n 609 Description Coupling, Reducing, 1" x 3/4"

Connector, Straight

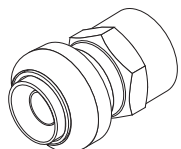

p/n 610 Description Connector, Straight, 1/2" x 1/2" FNPT
 p/n 611 Description Connector, Straight, 1" x 1" FNPT

Connector, Straight

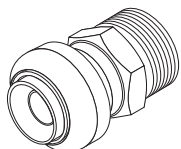

p/n 612 Description Connector, Straight, 1" x 3/4" MNPT

Connector, Straight

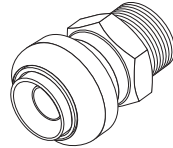

p/n 9264 Description Connector, Straight, 3/4" x 3/4" MIP

Elbow

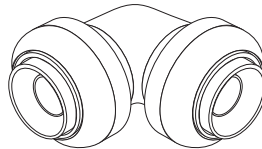

p/n 613 Description Elbow, 1" x 1"
 p/n 9265 Description Elbow, 3/4" x 3/4"

Tee

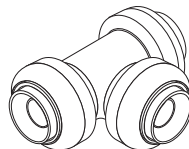

p/n 614 Description Tee, 1" x 1" x 1"

Temperature Gauge Fitting



1/8" MPT Temperature Gauge (p/n 6054) installs on Temperature Gauge Fitting and fitting installs on push-fit fitting Tee (p/n 614).

p/n 1350 Description Temperature Gauge Fitting, 1" Push-fit x 1/8" NPT

Depth Gauge/Deburring Tool

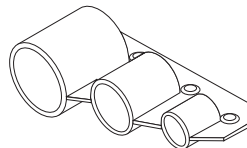

Deburs pipe and used to mark pipe to indicate when the pipe is inserted completely into the fitting. One tool for 1/2", 3/4" and 1" pipe.

p/n 615 Description Depth Gauge/Deburring Tool

Disconnect Clip

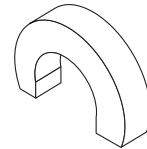

Used to disconnect push-fit fittings quickly and easily.

p/n 616 Description Disconnect Clip, 1/2"
 p/n 617 Description Disconnect Clip, 3/4"
 p/n 618 Description Disconnect Clip, 1"

Push-fit Fittings Water Heater Kit

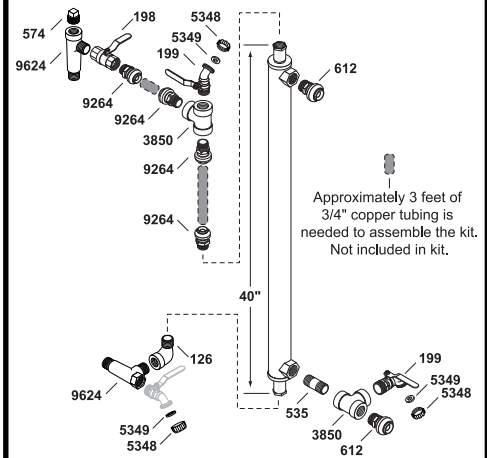

Install on existing domestic water heater for thermal circulating heat transfer. Water-to-water heat exchanger is sold separately.

p/n 9263 Description Push-fit Fittings Water Heater Kit

MAINTENANCE, REPLACEMENT AND OPTIONAL PRODUCTS

Water Softener Cartridge



For single use in filling water jacket, Water Softener Cartridge has 5,000 grains of removal capacity. For average water with 10 grains hardness, will treat 500 gallons water. May also be connected together to increase removal capacity.

p/n	Description
1310	Water Softener Cartridge

Corrosion Inhibitor Plus



Corrosion Inhibitor plus Polymer Solution helps protect exchangers and pumps against solids adhering to system parts. Refer to chart below for amounts used in each model furnace.

Models	Corrosion Inhibitor Amount
CL 4030	3/4 unit
CL 5036	1 unit
CL 6048	2 units
E-Classic 3200	2 units
E-Classic 2400	1-3/4 units
E-Classic 2300	2-1/2 units
E-Classic 1450	1 unit
E-Classic 1400	1 unit
Pallet Burner	3 units
CL 7260	4 units
Maxim M175, M250	1/2 unit

p/n	Description
1650	Corrosion Inhibitor Plus

Sludge Conditioner



NOTE: Sludge Conditioner should be used if the water quality is known to contain higher concentrations of minerals or solids. It is best to use softened water instead. If a furnace has been subjected to low Corrosion Inhibitor levels and corrosion is evident in the water jacket, Sludge Conditioner can be used to help clean some of the corrosion from inside the water jacket before flushing and refilling.

Reduces mineral deposits in boiler side of water-to-water heat exchangers. Refer to chart below for amounts used in each model furnace.

Models	Sludge Conditioner Amount
CL 4030	1/2 gal.
CL 5036, CL 6048	1 gal.
CL 7260, Pallet Burner	2 gal.

p/n	Description
166	Sludge Conditioner, 1 gal.

Water Test Kit

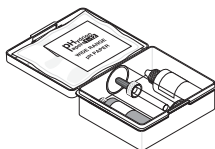

Water Test Kits and replacement items for testing your furnace water. Complete kits include pH test strips.

p/n	Description
405	Water Test Kit, Complete
597	Water Test Kit, Complete, Anti-Freeze Compatible
153	Litmus Paper
403	Permanganate
404	Sulfuric Acid

Decoiler

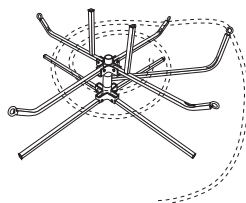

Useful when uncoiling and installing 1/2" tubing.

p/n	Description
1323	Decoiler

Temperature Gauges

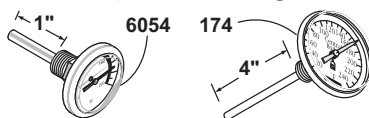

In-line, dial temperature gauge with 1/2" MPT (p/n 174) is optional for manifold, pool heater systems, etc. Gauge (p/n 6054) is 1/8" MPT, 1" diameter with 1" stem length, for use in tight areas.

p/n	Description
6054	Temp. Gauge, 1/8" MPT
174	Temp. Gauge, 1/2" MPT

Black Silicone Adhesive, High Temperature



100% silicone adhesive.

p/n	Description
806	Black Silicone Adhesive, High Temperature, 10.1 oz

Fuse & Socket

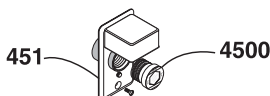

p/n	Description
4500	Fuse, 5-A
451	Socket, 5-A

Tile Tape



Recommended for taping Central Therm Insulation joints after gluing with contact cement.

p/n	Description
251	Tile Tape, roll

Grounding Rod Kit

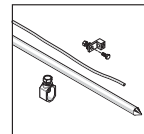

Used to electrically ground the furnace.

p/n	Description
6593	Grounding Rod Kit

Indoor Water Temperature Indicator Kit

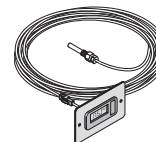

Remote inline monitoring of water temperature (battery operated). Includes LCD, 75 feet of cord and probe. Dip switch can be set to either Fahrenheit or Celsius. NOTE: Black Tee (p/n 133) and Hex Bushing (p/n 180) are not included with the kit.

p/n	Description
5052	Indoor Water Temperature Indicator Kit
133	Tee, Black, 3/4" NPT
180	Hex Bushing, 3/4" x 1/8"

Fan Center Relay

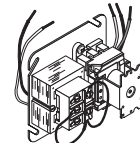

The Fan Center Relay is used to control a 110-volt fan with a 24-volt thermostat.

p/n	Description
515	Fan Center Relay

Fin Comb

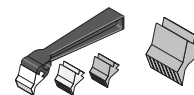

Tool with six interchangeable heads for straightening fins on water-to-air heat exchangers. For all units with 8, 9, 10, 11, 12 and 14 fins per inch.

p/n	Description
5918	Fin Comb

MAINTENANCE, REPLACEMENT AND OPTIONAL PRODUCTS - CLASSIC AND PALLET BURNER

Hoe

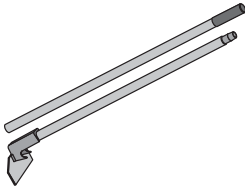

Used as a firebox maintenance tool, hoe comes with metal handle.

p/n	Description
308	Hoe

Ash Shovel

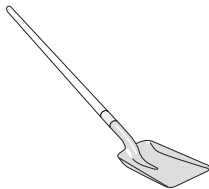

Used for removing ashes from furnace.

p/n	Description
299	Ash Shovel

Ash Rake

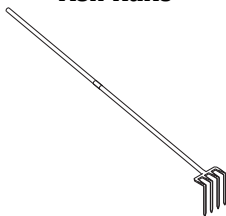

Long, metal-handled ash rake is used to pull coals forward and to stir ashes.

p/n	Description
300	Ash Rake

Ashtrol

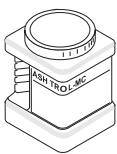

Used as a furnace firebox pH modifier.

p/n	Description
297	Ashtrol, 6.25 lbs

Vent Cap

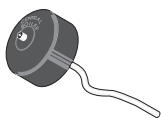

Replacement Vent Cap for Classic outdoor furnaces helps prevent water loss through the vent pipe.

p/n	Description
320	Vent Cap

Sight Gauge Components

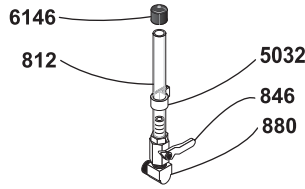

Sight Gauge Components replace original components.

p/n	Description
812	Sight Gauge Tube, 9/16" OD x 3/8" ID
5032	Clip
846	Valve, 1/4"
880	Elbow, 1/4"
6146	Dust Cap

Linkage



Linkage between the solenoid and damper control. Each linkage comes complete with cotter pins.

p/n	Description
1266	Linkage, All Linkage Models
1270	Linkage, Wire Loop Models
6869	Spring-Assisted Linkage, All Linkage Models

Door Lock Kit

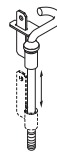

Prevents unauthorized access to the firebox.

p/n	Description
5575	Door Lock Kit, for steel-door CL 7260 and Pallet Burner
537	Door Lock Kit, for other Cam Loc models (including CL 7260 cast-iron door)

Cam Latch/Cam Loc Bushings with Collar

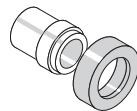

Replacement bushings with collar.

p/n	Description
4325	Cam Loc Bushing/Collar for CL 4030 and CL 5036 with s/n 93663 or lower
2500029	Cam Loc Bushing/Collar for CL 5036 with s/n 93664 or higher
4327	Cam Loc Bushing/Collar for CL 6048/Pallet Burner
4328	Cam Loc Bushing/Collar for CL 7260

Door Seal Rope

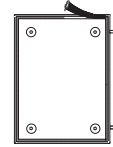

Sold either by the foot or in pre-cut lengths for specific model applications. Silicone is not included.

p/n	Description
7674	Rope, 7/8", priced per ft
7594	Door Seal Rope, 1", priced per ft
359	Door Seal Rope, 7/8", 8' for CL 4030, 5036
360	Door Seal Rope, 7/8", 9' for CL 6048
361	Door Seal Rope, 1", 12' for CL 7260
367	Door Seal Rope, 1", 23' for Pallet Burner

Door Seal Kit

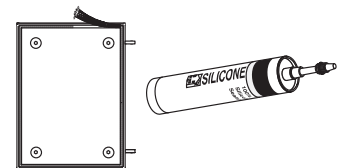

Kit includes Door Seal Rope cut to length and Black Silicone Adhesive.

p/n	Description
362	Door Seal Kit, for CL 4030, 5036
363	Door Seal Kit, for CL 6048
364	Door Seal Kit, for CL 7260
365	Door Seal Kit, for Pallet Burner

Draft Inducer

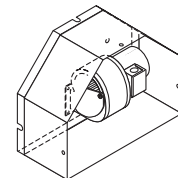

Bolts to existing draft hood (fan included). Must use 5-amp fuse. Do not use CL 7260 High-Output fan (p/n 5549) if a burner has been installed on the outdoor furnace. The 203 Blower & Motor, 1/15-hp can be used if a fan only is needed for the high output draft inducer. Draft Inducer (p/n 700) - 180 cfm; Draft Inducer (5549) - 450 cfm.

p/n	Description
400	Draft Inducer, Side Draft
500	Draft Inducer, Ripple Front Door
700	Draft Inducer, Flat Front Door
6576	Draft Inducer, CL 7260 Dual Fuel (w/fuses)
5549	Draft Inducer, CL 7260 High Output
203	Blower & Motor, 1/15-hp
8563	Draft Inducer Fan (only)

Solenoid

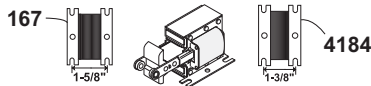

Because damper control solenoids are not interchangeable, check measurement and application dates carefully. Solenoid (p/n 167) is for pre-June 2000 models. Solenoid (p/n 4184) is for models after June 2000.

p/n	Description
167	Solenoid, 1-5/8" center-to-center bracket hole
4184	Solenoid, 1-3/8" center-to-center bracket hole

High Limit Switch/Snap Disc



High Limit Switch (p/n 192) opens on temperature rise. Snap Discs are Dual Fuel replacement snap discs (p/n 4099 is the center disc, p/n 5712 is for the left and right side discs).

p/n	Description
192	High Limit Switch, 190°F
4099	Snap Disc, 185-200°F
5712	Snap Disc, 145-160°F

Light Switch

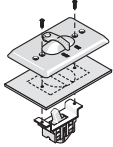

Includes cover plate and seal.

p/n	Description
187	Light Switch

Fuse Holder & Fuses

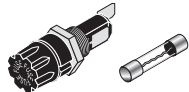

Various Fuses and Fuse Holder protect solenoid from overload. The 5-A fuse is for Dual Fuel models. The 1-A Slow Blow fuse is used with the door solenoid.

p/n	Description
1085	Fuse Holder
4501	Fuse, 3-A
6648	Fuse, 5-A
8470	Fuse, 1-A Slow Blow

Time Delay Relay



Replacement Time Delay Relay for Dual Fuel model furnaces.

p/n	Description
5775	Time Delay Relay

Digital Temperature Controller

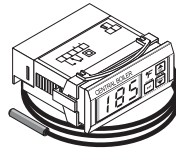

Replacement Digital Temperature Controller for Classic model outdoor furnaces only (after s/n 25151). Includes Temperature Sensing Wire (p/n 727).

p/n	Description
4221	Digital Temperature Controller

HeatTrac Controller Update Kits

Kits replace the HeatTrac Controller on furnaces. Kit (p/n 10904) is for furnaces with a hinged electrical box controller door. Kit (p/n 10902) is for furnaces with removable side panel cover.

p/n	Description
10904	HeatTrac Controller Update Kit (Models with Hinged Controller Door)
10902	HeatTrac Controller Update Kit (Models with Removable Side Panel Cover)

Temperature Sensing Wire



Replacement Temperature Sensing Wire for furnaces with a Digital Temperature Controller (p/n 4221).

p/n	Description
727	Temperature Sensing Wire

Relay Kit, Solid State

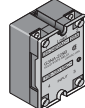

Provides protection for Digital Temperature Controller (p/n 5947): CL 4030 models prior to s/n 63671, CL 5036 models prior to s/n 63649, CL 6048 models prior to s/n 63781, CL 7260 models prior to s/n 64398.

p/n	Description
4527	Relay Kit - Classic models
4528	Relay Kit - Dual Fuel Ready models (except CL 7260)
4756	Relay Kit - CL 7260 models

Contact Block

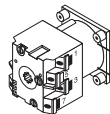

Replacement Contact Block for Dual Fuel furnaces.

p/n	Description
6497	Contact Block

Rocker Switch

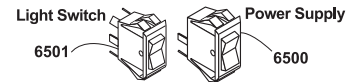

Replacement Rocker Switches for furnaces.

p/n	Description
6500	Rocker Switch, Power Supply (on-off)
6501	Rocker Switch, Light Switch (on-off-on)

Photoelectric Eye



Replacement Photoelectric Eye for furnaces.

p/n	Description
11998	Photoelectric Eye

Lens & Light Bulb

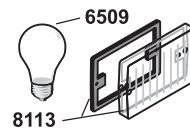

Replacement Lens w/Gasket and Light Bulb for furnaces.

p/n	Description
8113	Lens w/Gasket
6509	Light Bulb, 40 W

Selector Switch



Replacement Selector Switch for Dual Fuel furnaces.

p/n	Description
6498	Selector Switch

LED Temperature Display

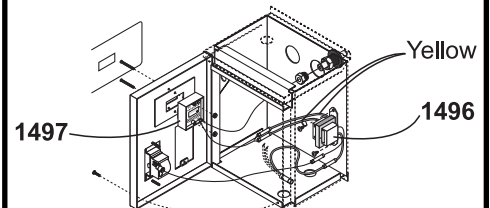

LED Temperature Display (on outdoor furnaces from s/n 13428 to s/n 25151) requires Transformer (p/n 1496) for converting 110-volt AC current to 12-volt DC current.

p/n	Description
1497	LED Temperature Display
1496	Transformer

MAINTENANCE, REPLACEMENT AND OPTIONAL PRODUCTS - E-CLASSIC

Latch Spring Clip



Replacement latch spring clips for rear panels and Reaction Chamber panel.

p/n	Description
4357	Latch Spring Clip

Gas Burner Valve

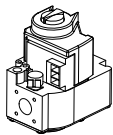

p/n	Description
10473	Gas Burner Valve

Gas Ignition Module

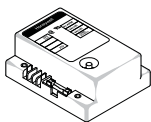

p/n	Description
6257	Gas Ignition Module

Gas Burner Kits

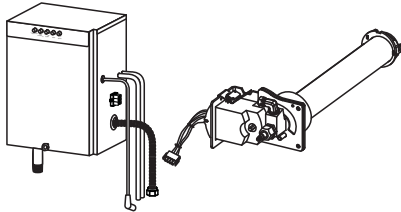

Optional LP gas burner for E-Classic 1400 IR, 1450 IR, 2400 IR and 3200 IR models.

p/n	Description
2500002	LP Gas Burner Kit, E-Classic 1400 IR Models
2500000	LP Gas Burner Kit, E-Classic 1450 IR Models
2500003	LP Gas Burner Kit, E-Classic 2400 IR Models
2500004	LP Gas Burner Kit, E-Classic 3200 IR Models

Natural Gas Conversion Kit

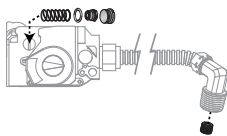

Converts E-Classic IR models with an optional LP gas burner (see above) from propane to natural gas.

p/n	Description
2500001	Natural Gas Conversion Kit, E-Classic IR Models

Natural Gas Conversion Kit



Converts E-Classic 2300 models from propane to natural gas.

p/n	Description
10598	Natural Gas Conversion Kit

Natural Gas Conversion Kit

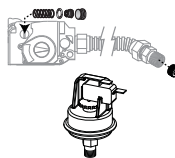

Converts E-Classic 1400 or 2400 models from propane to natural gas.

NOTE: NG Conversion Kit only needed for gas burner kits sold before Dec. 1, 2010. After that date, complete gas burner kits are available.

p/n	Description
10588	Natural Gas Conversion Kit, E-Classic 1400/2400

Digital Temp Controller



Replacement digital temperature controller for E-Classic 2300 wood-only models.

p/n	Description
8320	Digital Temp Controller

Blower Fan Assembly

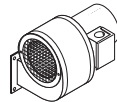

130 cfm Replacement Blower Fan Assembly (p/n 7259) for all E-Classic models except E-Classic 2300 models prior to s/n E17807 (for those models, use p/n 8563).

p/n	Description
7259	Blower Fan Assembly
8563	Blower Fan Assembly for E-Classic 2300 model prior to s/n E17808

Secondary Air Charge Tube

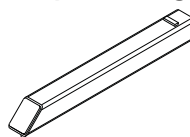

Replacement secondary air charge tube for E-Classic models.

p/n	Description
1200007	Secondary Air Charge Tube, E-Classic 1450
1200024	Secondary Air Charge Tube, E-Classic 2400
1200025	Secondary Air Charge Tube, E-Classic 3200

Firebrick



Replacement firebrick for E-Classic firebox. Dimensions: 9" x 4-1/2" x 1-1/4".

p/n	Description
8856	Firebrick

Firebrick



Replacement firebrick for E-Classic 2300 firebox. Dimensions: 4-1/2" x 4-1/2" x 1-1/4".

p/n	Description
8560	Firebrick

Grate Rod

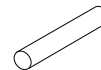

Replacement grate rod for E-Classic firebox.

p/n	Description
10420	Grate Rod

E-Classic 1400 Refractory Grates

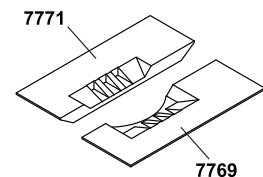

Replacement left center or right center ceramic refractory grate for E-Classic 1400.

p/n	Description
7771	Ceramic Refractory Grate - Left Center, E-Classic 1400
7769	Ceramic Refractory Grate - Right Center, E-Classic 1400

E-Classic 1450 Refractory - Upper

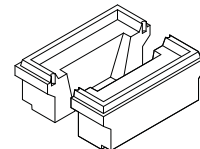

Replacement upper refractory for E-Classic 1450. Two upper refractory (p/n 4050001) are required per furnace.

p/n	Description
4050001	Refractory - Upper, E-Classic 1450

MAINTENANCE, REPLACEMENT AND OPTIONAL PRODUCTS - E-CLASSIC

E-Classic 1450 Refractory - End Cap

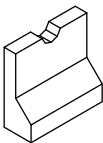

Replacement end cap refractory for E-Classic 1450.

p/n	Description
4050002	Refractory - End Cap, E-Classic 1450

E-Classic 2300 Refractory Grates

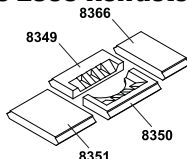

Replacement ceramic refractory grates for E-Classic 2300.

p/n	Description
8351	Ceramic Refractory Grate - Front
8366	Ceramic Refractory Grate - Rear
8349	Ceramic Refractory Grate - Left Center, E-Classic 2300
8350	Ceramic Refractory Grate - Right Center, E-Classic 2300

E-Classic 2400 Refractory - Upper

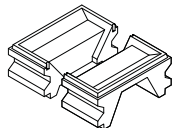

Replacement upper refractory for E-Classic 2400. Two upper refractory (p/n 10137) are required per furnace.

p/n	Description
10137	Refractory - Upper, E-Classic 2400

E-Classic 3200 Refractory - Firebox

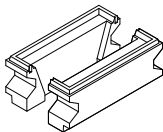

Replacement firebox refractory for E-Classic 3200.

p/n	Description
11174	Ceramic Refractory Grate - Firebox, E-Classic 3200

E-Classic 3200 Refractory - Firebox Door

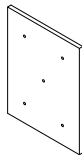

Replacement firebox door refractory for E-Classic 3200.

p/n	Description
11113	Ceramic Refractory Grate - Firebox Door, E-Classic 3200

E-Classic 3200 Refractory - Rear Lower Clean Out Door

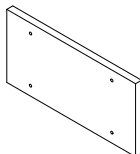

Replacement rear lower clean out door refractory for E-Classic 3200.

p/n	Description
11075	Ceramic Refractory Grate - Rear Lower Clean Out Door, E-Classic 3200

Ignitor Burner Gasket

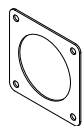

Replacement ignitor burner gasket for E-Classic 2300 models.

p/n	Description
8838	Ignitor Burner Gasket

Reaction Chamber Thermocouple

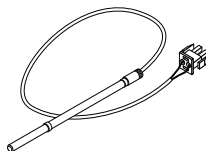

Replacement thermocouple for E-Classic models that utilize a thermocouple in the Reaction Chamber.

p/n	Description
7260	Thermocouple, Reaction Chamber

Door Seal

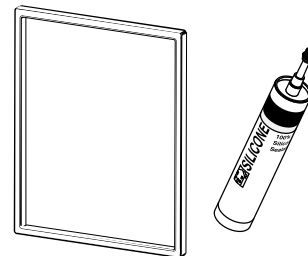

Pre-formed door seals for E-Classic model doors. Kits include Silicone Door Seal and Black Silicone Adhesive.

p/n	Description
2500027	Door Seal Kit, Silicone, for E-Classic 2300, 2400 and 3200
6000007	Door Seal only for E-Classic 2300, 2400 and 3200
2500028	Door Seal Kit, Silicone, for E-Classic 1400 and 1450
6000006	Door Seal only for E-Classic 1400 and 1450

Pulse Timer Kit

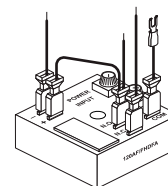

Adds an air pulse timer relay to E-Classic 2300 wood only models for setting the duration of the air pulse and the length of time between them. For E-Classic 2300 wood only models with a serial number prior to E17808.

p/n	Description
10835	Pulse Timer Kit

Water Level Float Switch

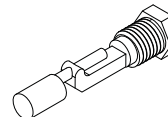

Replacement water level float switch for E-Classic and Maxim models.

p/n	Description
11430	Water Level Float Switch

MAINTENANCE, REPLACEMENT AND OPTIONAL PRODUCTS - E-CLASSIC

Flue Brush & Handle

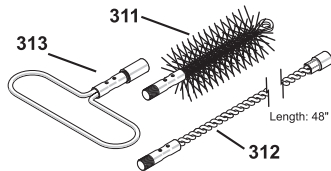

Used to clean the flue passageways of E-Classic 2300 models. Flue Brush Kit (p/n 310) includes 311, 312 and handle. Not to be used for cleaning 6" or 8" chimney.

p/n	Description
310	Flue Brush Kit

Heat Exchanger Scraper



Used to clean the flue passageways of E-Classic models.

p/n	Description
11384	Heat Exchanger Scraper, E-Classic 3200
2000023	Heat Exchanger Scraper, E-Classic 1450

Cleaning Rod

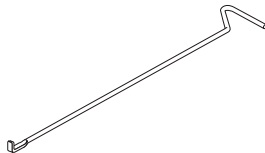

Used to clean the firebox of E-Classic models.

p/n	Description
9439	Cleaning Rod, E-Classic

Wonder Bar

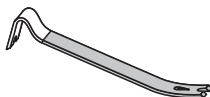

Used to clean the firebox of E-Classic models.

p/n	Description
10691	Wonder Bar

Ash Shovel

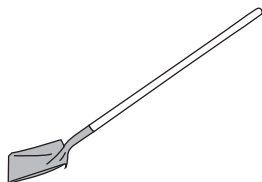

Used to remove ash from E-Classic models.

p/n	Description
1970	Ash Shovel

Turbulator - E-Classic 2300

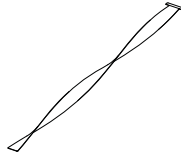

Replacement turbulators for E-Classic 2300 models. Note there are three different lengths.

p/n	Description
8866	Turbulator, Short
8867	Turbulator, Medium
8868	Turbulator, Long

LED Replacement Bulb/Plug

Replacement LED bulb/plug for E-Classic models.

p/n	Description
10486	LED, Roof Panel
10487	LED, Door

Fusion Combustor Kit

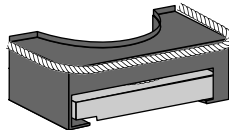

Fusion Combustor Kit for E-Classic 2300 models with a serial number of 15106 or earlier (Kit p/n 10700) or with a serial number of 15107 or higher (Kit p/n 10702). Kits include rectangular refractory, curved refractory, late-style Fusion Combustor, rope gaskets and firebrick.

p/n	Description
10700	Fusion Combustor Kit
10702	Fusion Combustor Kit
10639	Curved Refractory Only

Air Proving Switch Tubing

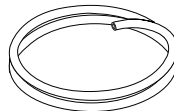

Clear tubing for the E-Classic air proving switch. Part number is per foot. 10 feet required for E-Classic models.

p/n	Description
3045	Air Proving Switch Tubing

Vent Cap

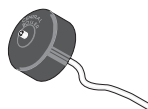

Replacement Vent Cap for E-Classic outdoor furnaces helps prevent water loss through the vent pipe.

p/n	Description
320	Vent Cap

2-Stage Gas Regulator Kit

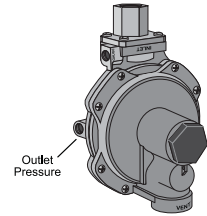

Regulates the gas pressure from an LP tank. For all E-Classic or Maxim models.

p/n	Description
1930	2-Stage Gas Regulator Kit

Spacer Bar Kit

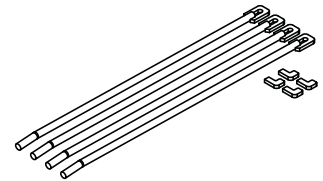

Installs on the sides of E-Classic 2300 firebox to prevent obstruction of primary combustion outlets.

NOTE: Installation of this kit involves welding inside the firebox and must be installed only by a qualified service technician.

p/n	Description
10844	Spacer Bar Kit

3-Conductor Shielded Cable

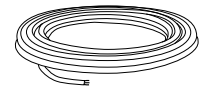

Used to connect FireStar II controller on outdoor furnace to FireStar XP wi-fi module. Available in 100-ft and 1,000-ft rolls.

p/n	Description
8200012	3-Conductor Shielded Cable, 100-ft roll
10489-SP	3-Conductor Shielded Cable, 1000-ft roll

CHIMNEY COMPONENTS - CLASSIC, E-CLASSIC AND PALLET BURNER

8" Classic Stainless Steel Chimney Sections

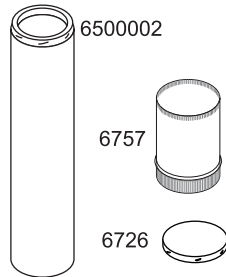

Type HT listed, factory-built, all stainless steel chimney section. If connecting to Chimney Extension (p/n 10508), use the 8" Chimney Band Clamp Kit (p/n 4518) at the joints. Sections are four feet long.

p/n	Description
6500002	Chimney Extension, 4'
6757	Chimney Conversion Adapter, 8"
6726	Chimney Rain Cap, 8"

8" E-Classic Stainless Steel Chimney Section

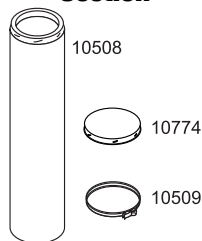

8" Stainless steel chimney currently shipped with E-Classic models (except E-CL 1450). Shipped with E-CL 1400 since s/n E100299 and E-CL 2300 since s/n E17856. Compatible with Chimney Extension (p/n 6500002). If connecting to Chimney Extension (p/n 6500002), use 8" Chimney Band Clamp Kit (p/n 4518) at the joints, not Chimney Locking Band (p/n 10509). For outdoor applications only. Not to be used for venting of indoor heating appliances.

p/n	Description
10508	Chimney Extension, 4'
10509	Chimney Locking Band
10774	Chimney Rain Cap, 8"

6" E-Classic 1450 Stainless Steel Chimney Sections



Type HT listed, factory-built, all stainless steel 6" chimney section. Sections are four feet long.

p/n	Description
6500004	Chimney Extension, 4'
4082	Chimney Rain Cap

6" Chimney Cap

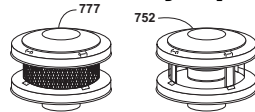

For E-CL 1450 chimney, with or without screen.

p/n	Description
777	Chimney Cap, 6" w/screen
752	Chimney Cap, 6" w/o screen

6" Chimney Band Clamp Kit

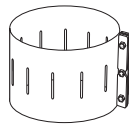

Reinforces strength between two sections of 6" chimney.

p/n	Description
9535	Chimney Band Clamp Kit, 6"

6" Chimney Attachment Ring

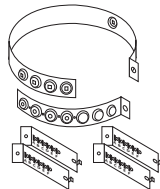

Used with electrical conduit (not included) to reinforce chimney when five or more sections are used. Must be located directly below 6" Chimney Band Clamp (p/n 9535) to reduce stress on the joint.

p/n	Description
774	Chimney Attachment Ring

6" Chimney Guy-Wire Band

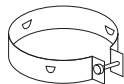

Attached to the outer casing of a 6" chimney to hold three guy-wires (not included). Recommended for chimneys exceeding the roof by 5' to 13' maximum.

p/n	Description
776	Guy-Wire Band

Chimney Tee Restrictor Kit

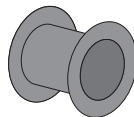

Installed in chimney tee to lower the burn rate. For use only with CL 4030, CL 5036 and CL 6048 models.

p/n	Description
10970	Chimney Tee Restrictor Kit

Chimney Tee Covers

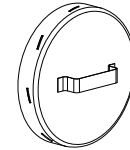

Replacement chimney tee covers.

p/n	Description
6165	10" Cover for Chimney Tee (p/n 11605)
6751	8" Cover for Chimney Tee (p/n 10998)
10775	8" Cover for Chimney Tees (p/n 6500000 and 6500001)

Chimney Components

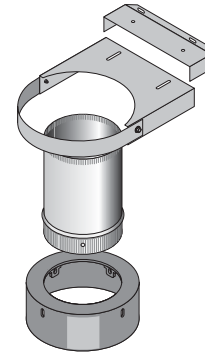

Chimney Adapter Kit (p/n 10895) converts CL 7260 and Pallet Burner models to the new chimney style (p/n 6500002). The conversion will require three Chimney Extensions (p/n 6500002).

Chimney Extension Components	
p/n	Description
10895	Chimney Adapter Kit, 10" to 8", for Pallet Burner and CL 7260 models
6172	Elbow, 8", 45-degree
6173	Chimney Section, 8" x 24" for Tower Installation

Stainless Steel Chimney Tees

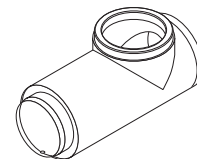

Type HT listed, factory-built, all stainless steel chimney tee. Kits include chimney tee cover and chimney tee rope rings, unless otherwise noted. NOTE: Silicone (p/n 806) is not included.

p/n	Description
10998	Chimney Tee Kit - CL4030, 5036 and 6048
11605	Chimney Tee Kit - CL 7260 and Pallet Burner
6500000	Chimney Tee* - E-Classic 1400 (s/n E100300 and later), E-Classic 2300 (s/n E17857 and later) and E-Classic 2400
6500001	Chimney Tee* - E-Classic 3200

*Does NOT include chimney tee rope rings. Must be purchased separately.

CHIMNEY COMPONENTS - CLASSIC, E-CLASSIC AND PALLET BURNER

Rope Ring

Replacement rope ring for chimneys. See table below for applications. When ordering p/n 7674 or 7594, specify the length in feet.

Model	Rope Ring part number	
	Between chimney connector and furnace	Below first chimney section
ECL 1400	3033	7632
ECL 1450	-	7674 (order 2 ft)
ECL 2300	3033	7632
ECL 2400	3033	7632
ECL 3200	3033	7632
CL 4030	3033	7632
CL 5036	3033	7632
CL 6048	3033	7632
CL 7260	7674 / 7584 (order 3 ft of each)	7632

p/n	Description
3033	Rope Ring, 1.5", 8" ID
7632	Rope Ring, 3/4", 8" ID
7674	Rope, 7/8", per foot
7594	Rope, 1", per foot

8" Spark Arrestor

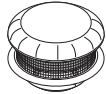

Stainless steel Spark Arrestor for the new-style chimney (p/n 6500002).

p/n	Description
396	Spark Arrestor

8" Chimney Band Clamp Kit

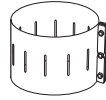

Reinforces strength between two sections of 8" chimney.

p/n	Description
4518	Chimney Band Clamp Kit, 8"

8" Chimney Base Brace Kit

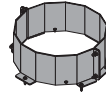

Used to reinforce the chimney base when three or more chimney sections are used.

p/n	Description
4519	Chimney Base Brace Kit, 8"

Chimney Attachment Ring

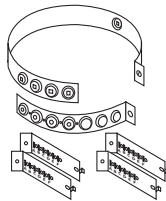

Used with electrical conduit (not included) to reinforce chimney when five or more sections are used. Must be located directly below 8" Chimney Band Clamp (p/n 4518) to reduce stress on the joint.

p/n	Description
774	Chimney Attachment Ring

8" Chimney Guy-Wire Band Kit



Used to provide additional stability to chimneys in installations where property damage could occur within the fall zone of the chimney. Guy wire is not included in kit.

p/n	Description
778	Chimney Guy-Wire Band Kit

Chimney Support Brace Kit

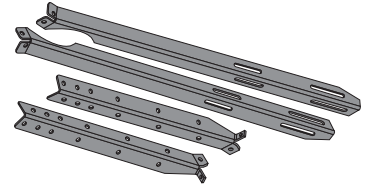

Reinforces strength of chimney support when several chimney sections are used. For use only with CL 4030, CL 5036 and CL 6048 models.

p/n	Description
4554	Chimney Support Brace Kit

Chimney Support Brace Kit

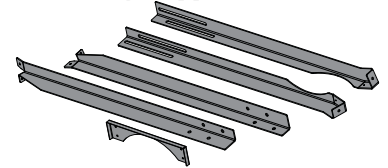

Reinforces strength of chimney support when several chimney sections are used. For use only with CL 7260 and Pallet Burner models.

p/n	Description
8402	Chimney Support Brace Kit

MAINTENANCE, REPLACEMENT AND OPTIONAL PRODUCTS - MAXIM

Vent Cap

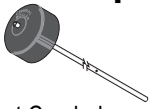

Replacement Vent Cap helps prevent water loss through the vent pipe and indicates water level. For M175 models only.

p/n	Description
319	Vent Cap - M175

Vent Cap

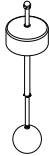

Replacement Vent Cap helps prevent water loss through the vent pipe and indicates water level. For M250 models only.

p/n	Description
9220	Vent Cap - M250

Snap Disc



Replacement snap discs.

p/n	Description
3533	Snap Disc, 185-225°F, (Back Burn)
4099	Snap Disc, 185-200°F, (High Limit Water Jacket)

Battery Clean Out Kit

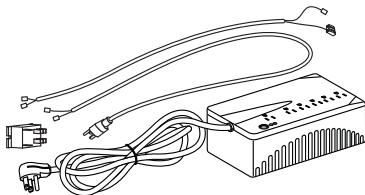

Equips M175 or M250 with a battery back up. Provides power to clean out the burner auger in the event of a back burn condition during a power failure. Kit includes UPS, wiring, relay and brackets for M175 and M250.

p/n	Description
2500005	Battery Clean Out Kit

Door Seal Rope/Chimney Transition Box Cover Seal Rope for Maxim



Rope may be used for door seal or chimney transition box cover seal (each requires a 5-ft section). Sold by the foot. Silicone is not included.

p/n	Description
809	Door Seal Rope, 3/4", priced per ft

Insulation

Transition Box Service Kit (p/n 4337) includes all insulation pieces for the chimney transition box.

p/n	Description
4337	Transition Box Service Kit
6287	Insulation, Door - M175

Hopper Extension Kit

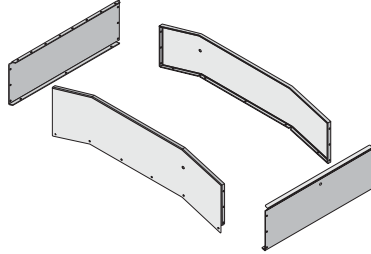

Increases hopper capacity by 3 bushels. For M175 models only.

p/n	Description
4536	Hopper Extension Kit - Green
4537	Hopper Extension Kit - Terra Brown

Hopper Lid Shock



Replacement Hopper Lid Shock for M175 or M250 models.

p/n	Description
4265	Hopper Lid Shock

48-Bushel Hopper Kit

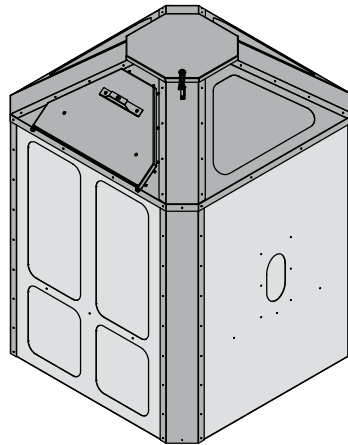

Increases fuel storage capacity for Maxim M175 and M250 models. Does not include auxiliary auger. Use the 5-1/2' Auxiliary Auger Kit (p/n 2500007) to locate the 48-Bushel Hopper to the side of the outdoor furnace. Available in either green and olive gray or terra brown and taupe to match the Maxim. Dimensions: 48" x 48" x 66".

p/n	Description
9760	48-Bushel Hopper Kit - Green and Olive Gray
9660	48-Bushel Hopper Kit - Terra Brown and Taupe

Auxiliary Auger Kits for Maxim

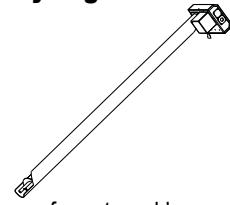

Transfer augers for external hoppers. Use 5-1/2' Auxiliary Auger Kit (p/n 2500007) with the 48-Bushel Hopper Kit (p/n 9660 or 9760) when the hopper is located to the side of the furnace. The 6' Auxiliary Auger Kit (p/n 2500008) and 8' Auxiliary Auger Kit (p/n 2500009) will not work with the 48-Bushel Hopper.

NOTE: For furnaces with a serial number prior to M16073, the Power Cord (p/n 4177) must be purchased separately.

p/n	Description
2500008	Auxiliary Auger Kit, 6'
2500007	Auxiliary Auger Kit, 5-1/2'
2500009	Auxiliary Auger Kit, 8'
4177	Power Cord (see note above)

Hopper Vibrator Kit

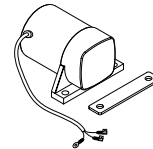

Vibrator attaches to the side of the Maxim's integrated hopper to keep fuel from bridging. Templates provided for both M175 or M250 models.

p/n	Description
9691	Hopper Vibrator Kit

Auxiliary Auger Vibrator w/Timer Kit

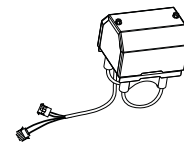

Vibrator is installed on the auxiliary auger connected to an external 43-bushel or 48-bushel hopper. For use with Auxiliary Auger Kits 2500007, 2500008 and 2500009 only. Vibration occurs based on timer setting.

p/n	Description
9458	Auxiliary Auger Vibrator w/Timer Kit

Bag Holder Kit

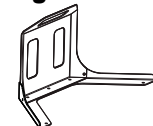

Bag Holder attaches to the inside of the door of the 48-Bushel Hopper to support bag of fuel.

p/n	Description
9804	Bag Holder Kit

MAINTENANCE, REPLACEMENT AND OPTIONAL PRODUCTS - MAXIM

Aerator

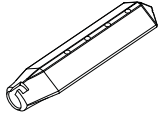

The aerator supplies oxygen to the fuel for the most complete combustion.

p/n Description
9710 Aerator, Stainless Steel

3/8" Cleaning Rod



Used to clean burn chamber.

p/n Description
317 3/8" Cleaning Rod

Ash Scoop

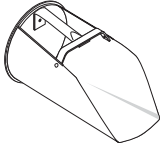

4-Quart galvanized Ash Scoop is ideal for cleaning ashes from furnace.

p/n Description
315 Ash Scoop

Round Pipe Caps



p/n Description
332 3/4" Round Pipe Cap
333 1-1/4" Round Pipe Cap

24V Transformer

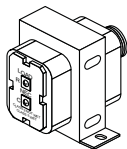

p/n Description
4045 24V Transformer

Propane Shut-off with Level Indicator

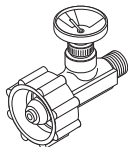

Used to monitor propane in a BBQ-style tank with Type 1 Acme threads connected to a Maxim furnace.

p/n Description
4220 Propane Shut-off with Level Indicator

Relay

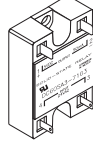

p/n Description
9504 Relay

Isolation Auger Motor Kit

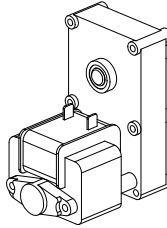

Replacement isolation auger motor with 1/8" gasket for Maxim furnaces. The M250 motor operates at 4.1 rpm. The M175 motor operates at 2.4 rpm.

p/n Description
9373 Isolation Auger Motor Kit, (includes gasket), M250
9372 Isolation Auger Motor Kit (includes gasket), M175

Burner Auger Motor

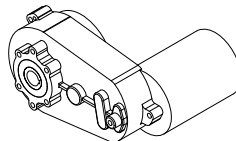

p/n Description
9787 Burner Auger Motor
5013 Burner Auger Motor Key

Air Proving Switch Replacement Kit

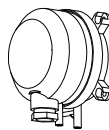

p/n Description
9268 Air Proving Switch Replacement Kit

Gas Burner Valve

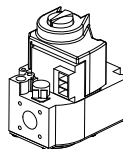

p/n Description
10473 Gas Burner Valve

Gas Ignition Module

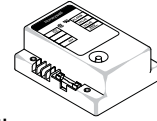

p/n Description
6257 Gas Ignition Module

Ignitor Wire Assembly



Includes rubber boot, spark plug wire terminal, spark plug wire and resistor cap.

p/n Description
9364 Ignitor Wire Assembly - M175
9542 Ignitor Wire Assembly - M250

Ignitor Spark Plug Wire - M250

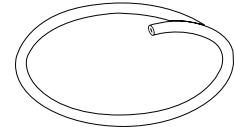

19" ignitor spark plug wire only for M250 models.

p/n Description
9544 Ignitor Spark Plug Wire only, 19" - M250

Ignitor - M250



p/n Description
9896 Ignitor - M250

Combustion Fan Kit

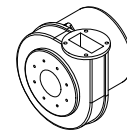

p/n Description
9423 Combustion Fan Kit

Gas Hose w/Regulator

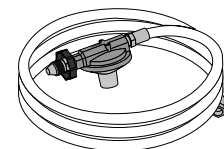

For use with M175 models only. Not recommended for use in cold weather.

p/n Description
5567 Gas Hose w/Regulator

MAINTENANCE, REPLACEMENT AND OPTIONAL PRODUCTS - MAXIM

2-Stage Gas Regulator Kit

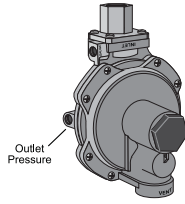

Regulates the gas pressure from an LP tank. For all E-Classic or Maxim models.

p/n 1930
Description
2-Stage Gas Regulator Kit

Burn Chamber w/Gasket

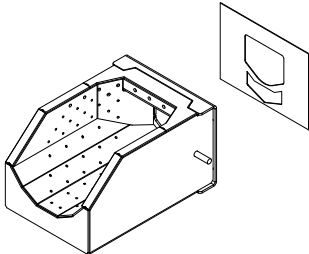

p/n 4286
Description
Burn Chamber w/Gasket, M175 models

Burn Chamber Gasket Only

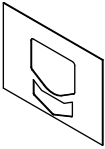

p/n 6179
Description
Burn Chamber Gasket Only, M175 models

Burn Chamber w/Gasket

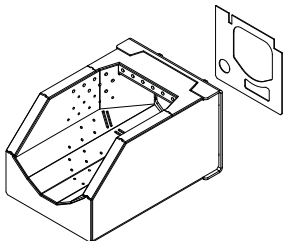

p/n 9299
Description
Burn Chamber w/Gasket, M250 models

Burn Chamber Gasket Only

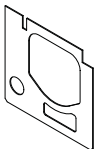

p/n 9145
Description
Burn Chamber Gasket Only, M250 models

Firebox Temp Sensor

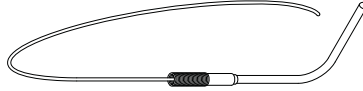

Replacement sensor for M175 models.

p/n 4288
Description
Firebox Temp Sensor, M175

Firebox Temp Sensor

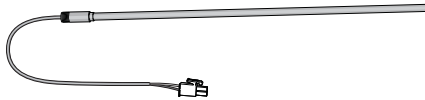

Replacement sensor for M250 models.

p/n 9257
Description
Firebox Temp Sensor, M250

Door Latch

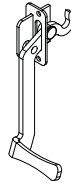

p/n 4417
Description
Door Latch, Bottle Green
4196-021 Door Latch, Terra Brown

Burner Auger

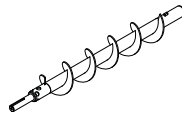

p/n 9701
Description
Burner Auger, M175
9702 Burner Auger, M250

Turbulator - M175



p/n 6435
Description
Turbulator - M175

Water Level Float Switch

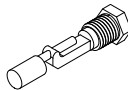

Replacement water level float switch for E-Classic and Maxim models.

p/n 11430
Description
Water Level Float Switch

Inspection Window Components

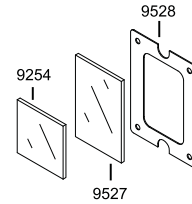

Replacements for M250 inspection window. 2" x 2" window for M250 models with s/n M2000002 to M2000063. 2" x 3" window for models with s/n M2000064 and higher.

p/n 9254
Description
Inspection Window, 2" x 2"
9527 Inspection Window, 2" x 3"
9528 Inspection Window Gasket

Flue Brush & Handle

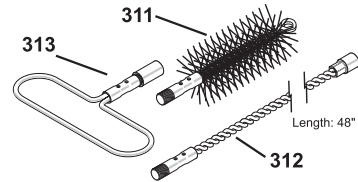

Used to clean the flue passageways of M175 models. Flue Brush Kit (p/n 310) includes 311, 312 and handle. Not to be used for cleaning 6" or 8" chimney.

p/n 310
Description
Flue Brush Kit

Flue Brush & Handle



Used to clean the flue passageways of M250 models. Flue Brush Kit (p/n 390) includes 398, 312 and handle. Not to be used for cleaning 6" or 8" chimney.

p/n 390
Description
Flue Brush Kit

Digital Pocket Multimeter

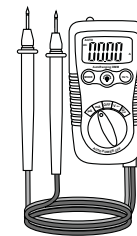

Digital multimeter performs several electrical measurement functions in one simple-to-use instrument.

p/n 2657
Description
Digital Pocket Multimeter

CHIMNEY COMPONENTS - MAXIM

6" Maxim Stainless Steel Chimney Sections



Type HT listed, factory-built, all stainless steel 6" chimney section. Sections are four feet long.

p/n	Description
6797	Chimney Extension, 4'
4082	Chimney Rain Cap

Maxim Chimney Lengths

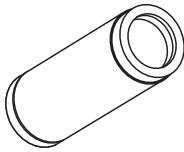

Three lengths of insulated chimney to obtain the required installation height. Features a 1/8-turn Twist-Lock assembly.

p/n	Description
757	Chimney Length, 12"
758	Chimney Length, 24"
759	Chimney Length, 36"

6" Chimney Cap

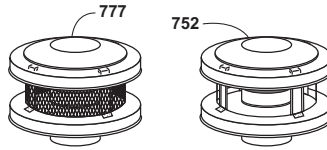

Cap for 6" chimney, with or without screen.

p/n	Description
777	Chimney Cap, 6" w/screen
752	Chimney Cap, 6" w/o screen

6" Chimney Band Clamp Kit

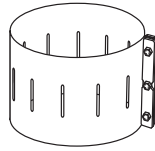

Reinforces strength between two sections of 6" chimney.

p/n	Description
9535	Chimney Band Clamp Kit, 6"

Chimney Attachment Ring

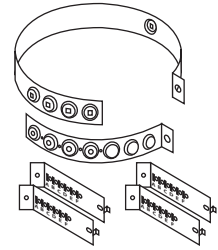

For use on an interior or exterior wall, stabilizes chimney while providing required clearance from combustible surface. Use of Chimney Attachment Rings at maximum intervals of 8' is recommended.

p/n	Description
774	Chimney Attachment Ring

Guy-Wire Band

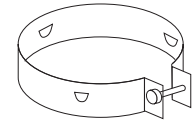

Attached to the outer casing of the chimney to hold three guy-wires (not included). Recommended for chimneys exceeding the roof by 5' to 13' maximum.

p/n	Description
776	Guy-Wire Band

NUMERICAL PARTS LIST

100	Soldering Flux (6 oz)	10	300	Ash Rake	17	610	Connector, Straight, 1/2" x 1/2" FNPT	15
101	Hot Filter, 3/4" FIP	11	301	Air Handler Cabinet, 100k-140k Btu, front access	4	611	Connector, Straight, 1" x 1" FNPT	15
102	Heat Exchanger Coil, 95k Btu	2	303	Air Handler Cabinet, 185k-220k Btu, front access	4	612	Connector, Straight, 1" x 3/4" MNPT	15
103	Street Elbow, 1"	14	306	Radiant Mixing Valve, 1/2" NPT fittings	13	613	Elbow, 1" x 1"	15
104	Clamp Crimp Ring Removal Tool	7	308	Hoe	17	614	Tee, 1" x 1" x 1"	15
105	Hex Bushing, 1-1/2" x 3/4"	10	310	Flue Brush Kit	21, 26	615	Depth Gauge/Deburring Tool	15
106	Heat Exchanger Coil, 100k Btu	2, 3	314	Nipple, 1-1/2" x close	10	616	Disconnect Clip, 1/2"	15
107	Heat Exchanger Coil, 125k Btu, straight outlets	2	315	Ash Scoop	25	617	Disconnect Clip, 3/4"	15
108	Heat Exchanger Coil, 140k Btu	2, 3	317	3/8" Cleaning Rod	25	618	Disconnect Clip, 1"	15
109	Heat Exchanger Coil, 80k Btu	2	318	Heat Exchanger, Water-to-Water, Double Wall, 42"	8	620	Water Heater Mixing Valve, Low Lead, 3/4" sweat fittings	13
110	Heat Exchanger Coil, 185k Btu	2	319	Vent Cap - M175	24	671	2-Way Zone Valve, 24-Volt, 1" sweat fittings	13
111	Heat Exchanger Coil, 220k Btu	2	320	Vent Cap	17, 21	672	Central Therm Sleeve, 800'	7
112	Vent Elbow, 1" x 1" sweat fittings	14	321	Space Heater Cabinet	3	700	Draft Inducer, Flat Front Door	17
113	Replacement Head	13	322	Fan	2	704	Heat Exchanger Coil, 125k Btu, 90' outlets	2
114	3-Way Zone Valve, 24-Volt, 1" sweat fittings	13	323	Transition	2	727	Temperature Sensing Wire	18
116	Male Adapter, 3/4" sweat x 3/4" MIP fittings	14	324	Crimp Ring Tool, 1/2"	6	751	Firestop	27
117	Female Adapter, 3/4" sweat x 3/4" FIP fittings	14	325	Hex Bushing, 3/4" x 1/2"	10	752	Chimney Cap, 6" w/o screen	22, 28
118	Nipple, 3/4" x close	10	326	Water Heater Mixing Valve, 3/4" NPT fittings	13	754	Flashing, Adjustable Roof, 8/12 to 12/12 Pitch	28
119	Pump Flange Kit, 3/4"	5	327	Radiant Mixing Valve, 3/4" NPT fittings	13	757	Chimney Length, 12"	27
120	Male Adapter, 1" sweat x 1" MPT fittings	14	329	Radiant Mixing Valve, 1" NPT fittings	13	758	Chimney Length, 24"	27
123	90° Reducing Elbow, Copper Pipe, 1" x 3/4" sweat fittings	14	330	3-Way Valve, Brass 3/4" FIP	11	759	Chimney Length, 36"	27
124	45° Street Elbow, 3/4"	10	331	Pipe Plug, 3/4"	10	760	Chimney Elbow, 15°	27
126	90° Street Elbow, Brass, 3/4"	10	332	3/4" Round Pipe Cap	25	761	Chimney Elbow, 30°	27
127	3-Way Zone Valve, 24-Volt, 3/4" sweat fittings	13	333	1-1/4" Round Pipe Cap	25	763	Attic Radiation Shield	27
128	Plate Exchanger, MPN 5 x 12-40, 1-1/4" Port	8	336	Pipe Plug, 1-1/2"	10	764	Radiation Shield	27
129	Plate Exchanger, MPN 5 x 12-50, 1-1/4" Port	8	353	Louvers, fit Heat Exchanger Coil (p/n 111)	2	765	Firestop	27
133	Tee, Black, 3/4" NPT	10, 16	354	Louvers, fit Heat Exchanger Coil (p/n 108)	2	766	Flashing, Flat Roof	27
134	Purging and Filling Tee, 1"	12	355	Louvers, fit Heat Exchanger Coil (p/n 106)	2	767	Flashing, Adjustable Roof, 1/12 to 7/12 Pitch	28
138	Tee, Copper Pipe, 1" x 1" x 1" sweat fittings	14	359	Door Seal Rope, 7/8", 8' for CL 4030, 5036	17	768	Flashing, Adjustable Roof, 12/12 to 21/12 Pitch	28
140	Tempering Valve, 3/4" sweat fittings	13	360	Door Seal Rope, 7/8", 9' for CL 6048	17	769	Universal Roof Support	27
145	Crimp Ring Tool, 1"	6	361	Door Seal Rope, 1", 12' for CL 7260	17	770	Universal Offset/Wall Support	27
146	Copper Coupling, 3/4" sweat x 3/4" sweat fittings	14	362	Door Seal Kit, for CL 4030, 5036	17	771	Wall Radiation Shield	27
147	Copper Coupling, 1" sweat x 1" sweat fittings	14	363	Door Seal Kit, for CL 6048	17	774	Chimney Attachment Ring	22, 23, 28
148	Water-to-Water Heat Exchanger, Shell & Tube, 27"	9	364	Door Seal Kit, for CL 7260	17	775	Universal Roof Brace	28
151	Water-to-Water Heat Exchanger, Shell & Tube, 60"	9	365	Door Seal Kit, for Pallet Burner	17	776	Guy-Wire Band	22, 28
153	Litmus Paper	16	367	Door Seal Rope, 1", 23' for Pallet Burner	17	777	Chimney Cap, 6" w/screen	22, 28
154	Blower & Motor, 1/4-hp 3-speed fan	3	368	Plug-in Thermostat	13	778	Chimney Guy-Wire Band Kit	23
163	Tempering Valve, 1/2" sweat fittings	13	372	Vent Elbow, 3/4" x 3/4" sweat fittings	14	806	Black Silicone Adhesive, High Temperature, 10.1 oz	16
164	Female Adapter, 1" sweat x 3/4" FIP fittings	14	373	Drain Coupling, Copper Pipe, 3/4" x 3/4" sweat fittings	14	809	Door Seal Rope, 3/4", priced per ft	24
166	Sludge Conditioner, 1 gal.	16	376	Copper Cap, 1"	8, 14	812	Sight Gauge Tube, 9/16" OD x 3/8" ID	17
167	Solenoid, 1-5/8" center-to-center bracket hole	18	378	Cleaning Brush, 3/4"	10	846	Valve, 1/4"	17
169	Adjustable Aquastat	13	379	Cleaning Brush, 1"	10	848	Motor Frame	2
170	Replacement Cartridge, 007 Series Pumps	5	380	Male Adapter, 1-1/4" barb x 1-1/4" MIP	12	849	Transition	2
171	Taco 007 Pump	5	381	Brass Coupling, 1-1/4" barb x 1-1/4" barb	7, 12	851	Fan Blades	2
172	Replacement Cartridge, 009 Series Pumps	5	382	Brass Elbow, 1-1/4" barb x 1-1/4" barb	12	880	Elbow, 1/4"	17
173	Taco 009 Pump	5	383	Pipe Plug, 1-1/4"	10	956	Elbow, 90-degree, 3/4" x 3/4" FPT	3, 10
174	Temp. Gauge, 1/2" MPT	16	385	Brass Hex Bushing, 1-1/2" x 3/4"	12	1085	Fuse Holder	18
175	Taco 006 Pump	5	386	PEX 1-1/4" Pipe, 300'	12	1097	Universal Heat Exchanger Mounting Kit	8
176	Taco 014 Pump	5	388	Hex Bushing, 1-1/4" x 3/4"	10	1247	Well, 1/2" NPT fitting	13
177	Heat Exchanger, Water-to-Water, Shell & Tube, 48"	9	390	Flue Brush Kit	26	1248	Well, SS, 1/2" NPT fitting	13
178	Reducing Tee, 1-1/2" x 1" x 1" sweat fittings	14	395	Manifold	11	1266	Linkage, All Linkage Models	17
179	Replacement Cartridge, 014 Series Pumps	5	396	Spark Arrestor	23	1267	Line Voltage Thermostat	13
180	Hex Bushing, 3/4" x 1/8"	10, 16	400	Draft Inducer, Side Draft	17	1270	Linkage, Wire Loop Models	17
182	Baseboard Corner, Inside	14	403	Permanganate	16	1272	Pump Flange Kit, 1-1/4"	5
183	Baseboard Corner, Outside	14	404	Sulfuric Acid	16	1280	Fan Motor	2
186	Ball Valve, 1/2"	11	405	Water Test Kit, Complete	16	1302	Central PEX 1" Pipe, 10' straight section, 5 per bag	6
187	Light Switch	18	407	Cast Iron Manifold	11	1303	Central PEX 1" Pipe, 10' straight section, 20 per bag	6
188	24-Volt Transformer	13	408	Hex Bushing, 1-1/2" x 1-1/4"	10	1310	Water Softener Cartridge	16
191	Pool Aquastat, 1/2" NPT fitting	13	409	Nipple, 1-1/4" x close	10	1311	Central PEX 1" Pipe, 100'	6
192	High Limit Switch, 190 F	18	410	Ball Valve, 1-1/4"	11	1312	Central PEX 1" Pipe, 200'	6
194	Pump Flange Kit, 1"	5	411	90° Street Elbow, 1-1/4"	10	1313	Central PEX 1" Pipe, 300'	6
195	PEX Pipe Cutter	6	412	Hex Bushing, 1-1/4" x 1/2"	10	1314	Central PEX 1" Pipe, 500'	6
198	Ball Valve, 3/4" Full Port	11	413	Taco 007 Priority Pump	5	1320	Central PEX 1/2" Pipe, 300'	6
199	Brass Hose Bib, 3/4" MPT	10	415	Transition	3	1321	Central PEX 1/2" Pipe, 500'	6
200	Sweat Ball Valve, 3/4" x 3/4" sweat fittings	14	416	Transition	3	1322	Central PEX 1/2" Pipe, 1000'	6
201	Flow Check Valve, 1" threaded	8	418	Tee, Black, 1-1/4" NPT	10	1323	Decoiler	16
202	Cartridge, #10	11	451	Socket, 5-A	16	1324	PEX Adapter, 1" PEX x 1" MIP fittings	6
203	Blower & Motor, 1/15-hp	3, 17	500	Draft Inducer, Ripple Front Door	17	1325	Solder	8
204	Adjustable Aquastat	13	506	Central Therm Sleeve Dispenser	7	1329	Manifold w/Valves, 3-Loop	10
208	Blower & Motor, 1-hp	3	515	Fan Center Relay	16	1330	PEX Adapter, 1" PEX x 3/4" MIP fittings	6
219	Replacement Cartridge, 011 Series Pumps	5	524	Central Therm Sleeve, 100'	7	1331	PEX Adapter, 1" PEX x 1" sweat fittings	6
222	Replacement Cartridge, 006 Series Pumps	5	525	Central Therm Sleeve, 200'	7	1332	PEX Tee, 1"	6
224	"Free Floating" Flange Kit, 3/4"	5	526	Central Therm Sleeve, 300'	7	1333	PEX Coupling, 1"	6, 7
225	Isolation Flange Kit, 1-1/4"	5	527	Central Therm Sleeve, 500'	7	1334	PEX 90° Elbow, Brass, 1"	6
226	Isolation Flange with Drain Valve, 3/4"	5	533	Nipple, 3/4" x 2"	10	1335	PEX Crimp Ring, 1"	6
230	Baseboard Joinder	14	534	Nipple, 3/4" x 7"	10	1336	PEX Adapter, 1/2" PEX x 3/4" MIP fittings	6
231	Reducer, Copper Pipe, 1" x 3/4" sweat fittings	14	535	Nipple, Brass, 3/4" x 2"	10	1337	PEX Adapter, 1/2" PEX x 1/2" sweat fittings	6
232	Baseboard End Cap, Left	14	536	Nipple, Brass, 3/4" x 7"	10	1338	PEX Tee, 1/2"	6
233	Baseboard End Cap, Right	14	537	Door Lock Kit, for other Cam Loc models (including CL 7260 cast-iron door)	17	1339	PEX Coupling, 1/2"	6
234	Baseboard, Complete, 2'	14	542	O-Ring Set	5	1340	PEX 90° Elbow, Brass, 1/2"	6
235	Baseboard, Complete, 3'	14	556	Power Supply Cord, 32"	5	1341	PEX Adapter, 1/2" PEX x 1/2" MIP fittings	6
236	Baseboard, Complete, 4'	14	571	2-Way Zone Valve, 24-Volt, 3/4" sweat fittings	13	1342	PEX Crimp Ring, 1/2"	6
237	Baseboard, Complete, 5'	14	573	Y-Strainer, 1" Brass	11	1348	PEX Adapter, 1/2" PEX x 1/2" FIP fittings	6
238	Baseboard, Complete, 6'	14	574	Pipe Plug, Brass 3/4"	10	1349	Manifold w/Valves, 2-Loop	8
241	Central Therm Insulation, 8'	7	587	Multi-stage 24-Volt Thermostat	13	1350	Temperature Gauge Fitting, 1" Push-fit x 1/8" NPT	15
242	Central Therm Insulation, 4'	7	588	Programmable 24-Volt Thermostat	3, 13	1360	PEX Piping Mounting Kit	7
251	Tile Tape, roll	16	588	Programmable 24-Volt Thermostat	13	1365-011	Mounting Bracket for 3/4" NPT Thermostatic Valve	11
255	Tee, Copper Pipe, 3/4" x 3/4" x 3/4" sweat fittings	14	591	Water-to-Water Heat Exchanger, 40"	9	1366	Pump Wall Mount Kit	5
274	90° Street Elbow, 3/4"	10	597	Water Test Kit, Complete, Anti-Freeze Compatible	16	1370-011	Mounting Bracket for 1-1/4" NPT Thermostatic Valve	11
276	90° Elbow, Copper Pipe, 3/4" x 3/4" sweat fittings	14	600	Panel Radiator, 32" x 16"	9	1496	Transformer	18
277	90° Elbow, Copper Pipe, 1" x 1" sweat fittings	14	601	Panel Radiator, 35-1/2" x 24"	9	1497	LED Temperature Display	18
286	Automatic Vent Valve	9	602	Panel Radiator, 51-1/2" x 24"	9	1548	3/4" NPT Thermostatic Valve Fittings Kit	11
287	Heat Exchanger Coil, 50k Btu	2	603	Panel Radiator, 55-1/4" x 24"	9	1621	1-1/4" NPT Thermostatic Valve	11
290	Fixed Aquastat, 175 F	13	604	TRV II Valve Body and Head, 1/2" Vertical	9	1624	1-1/4" NPT Thermostatic Valve Fittings Kit	11
293	PEX Hanger, 1/2"	7	605	LKD Valve Body with No Cap, 1/2" Preset Flow Rate	9	1650	Corrosion Inhibitor Plus	16
295	PEX Hanger, 1"	7	606	Coupling, Straight, 1/2" x 1/2"	15	1694	Y-Strainer, 1-1/4" Black	11
296	Brass Swing Check Valve, 3/4"	11	607	Coupling, Straight, 3/4" x 3/4"	15	1695	Y-Strainer, 3/4" Brass	11
297	Ashtrol, 6.25 lbs	17	608	Coupling, Straight, 1" x 1"	15	1745	Central Boiler Clamp, 1-1/4"	6
299	Ash Shovel	17	609	Coupling, Reducing, 1" x 3/4"	15	1880	Manifold w/o Valves, 2-Loop	8

NUMERICAL PARTS LIST

1885	Manifold w/o Valves, 3-Loop	8	6498	Selector Switch	18	10895	Chimney Adapter Kit, 10" to 8"	
1910	Fan Convactor, Corner, 7k Btu	3	6500	Rocker Switch, Power Supply (on-off)	18		For Pallet Burner and CL 7260 models	22
1930	2-Stage Gas Regulator Kit	21, 26	6501	Rocker Switch, Light Switch (on-off-on)	18	10902	HeatTrac Controller Update Kit	
1938	Air Filter, 10" x 10" x 1"	3	6509	Light Bulb, 40 W	18		(Models with Removable Side Panel Cover)	18
1941	Fan Convactor, Wall Mount, 7k Btu	3	6557	Pipe Plug, Brass 1/2"	10	10904	HeatTrac Controller Update Kit	
1970	Ash Shovel	21	6576	Draft Inducer, CL 7260 Dual Fuel (w/fuses)	17		(Models with Hinged Controller Door)	18
1971	Fan Convactor, 26k Btu	3	6593	Grounding Rod Kit	16	10970	Chimney Tee Restrictor Kit	22
2053	Fittings Kit	9	6648	Fuse, 5-A	6	10998	Chimney Tee Kit - CL4030, 5036 and 6048	22
2441	ThermoPEX, 1", 100' Roll	7	6679	Female Adapter, 1/2" barb x 1/2" sweat fittings	18	11075	Ceramic Refractory Grate - Rear Lower Clean	
2443	ThermoPEX Cap, 1"	7	6726	Chimney Rain Cap, 8"	22		Out Door, E-Classic 3200	20
2447	ThermoPEX Coupling Kit, 1"	7	6751	8" Cover for Chimney Tee (p/n 6725)	22	11113	Ceramic Refractory Grate - Firebox Door,	
2491	ThermoPEX, 1", 800' Roll	7	6757	Chimney Conversion Adapter, 8"	22		E-Classic 3200	20
2492	ThermoPEX, 1-1/4", 300' Roll	7	6764	Brass Offset Tee, 4"	10	11157	Nipple, Schedule 80, Black, 1-1/4" x 3"	10
2494	ThermoPEX Cap, 1-1/4"	7	6773	Myson Whispa II Kickspace 9000 Fan Convactor	4	11174	Ceramic Refractory Grate - Firebox, E-Classic 3200	20
2495	ThermoPEX Coupling Kit, 1-1/4"	7	6776	Myson Lo-Line RC 6-4 Fan Convactor	4	11384	Heat Exchanger Scraper, E-Classic 3200	21
2657	Digital Pocket Multimeter	26	6777	Myson Hi-Line HL 7-4 Fan Convactor	4	11430	Water Level Float Switch	20, 26
2799	ThermoPEX, 1-1/4", 100' Roll	7	6778	Myson Slim-Line RC Fan Convactor	4	11605	Chimney Tee Kit - CL 7260 and Pallet Burner	22
3033	Rope Ring, 1.5", 8" I.D.	23	6782	Diverter Tee, 1" x 1" x 1/2"	4	11998	Photoelectric Eye	18
3042	Brass Hex Bushing, 1/2" x 1/8"	10	6797	Chimney Extension, 4"	27	1200007	Secondary Air Charge Tube, E-Classic 1450	19
3045	Air Proving Switch Tubing	21	6869	Spring-Assisted Linkage, All Linkage Models	17	1200024	Secondary Air Charge Tube, E-Classic 2400	19
3533	Snap Disc, 185-225 F. (Back Burn)	24	7259	Blower Fan Assembly	19	1200025	Secondary Air Charge Tube, E-Classic 3200	19
3822	Kit for 301 - back water access	4	7260	Thermocouple, Reaction Chamber	20	1200033-011	Manifold, 1-1/4" Inlet x (4) 3/4" Outlets	11
3825	Kit for 303 - back water access	4	7594	Rope, 1", per foot	17, 23	1200034-011	Manifold, 1-1/4" Inlet x (4) 1-1/4" Outlets	11
3850	Tee, Brass, 3/4" NPT	10	7594	Door Seal Rope, 1", per ft.	23	2000023	Heat Exchanger Scraper, E-Classic 1450	21
3851	Brass Hex Bushing, 1-1/4" x 3/4"	10	7632	Rope Ring, 3/4", 8" ID	23	2500000	LP Gas Burner Kit, E-Classic 1450 IR Models	19
4045	24V Transformer	25	7674	Rope, 7/8", priced per ft.	17, 23	2500001	Natural Gas Conversion Kit, E-Classic IR Models	19
4082	Chimney Rain Cap	22, 27	7769			2500002	LP Gas Burner Kit, E-Classic 1400 IR Models	19
4099	Snap Disc, 185-200 F.	18, 24	7771			2500003	LP Gas Burner Kit, E-Classic 2400 IR Models	19
4177	Power Cord	24				2500004	LP Gas Burner Kit, E-Classic 3200 IR Models	19
4184	Solenoid, 1-3/8" center-to-center bracket hole	18				2500005	Battery Clean Out Kit	24
4196-021	Door Latch, Terra Brown	26	8113	Lens w/Gasket	19	2500007	Auxiliary Auger Kit, 5-1/2'	24
4220	Propane Shut-off with Level Indicator	25	8320	Digital Temp Controller	19	2500008	Auxiliary Auger Kit, 6'	24
4221	Digital Temperature Controller	18	8349	Ceramic Refractory Grate - Left Center,		2500009	Auxiliary Auger Kit, 8'	24
4265	Hopper Lid Shock	24	8350	E-Classic 2300	20	2500013	Fittings Kit, threaded ports	8
4286	Burn Chamber w/Gasket, M175 models	26		Ceramic Refractory Grate - Right Center,		2500024	3/4" NPT Thermostatic Valve	11
4288	Firebox Temp Sensor, M175	26		E-Classic 2300	20	2500027	Door Seal Kit, Silicone, for E-Classic	
4325	Cam Loc Bushing/Collar for CL 4030/CL 5030	17	8351	Ceramic Refractory Grate - Front	20		2300, 2400 and 3200	20
4327	Cam Loc Bushing/Collar for CL 6048/Pallet Burner	17	8364	Backflow Preventer, 3/4"	12	2500028	Door Seal Kit, Silicone, for E-Classic 1400 and 1450	20
4328	Cam Loc Bushing/Collar for CL 7260	17	8366	Ceramic Refractory Grate - Rear	20	2500029	Cam Loc Bushing/Collar for CL 5036	17
4337	Transition Box Service Kit	24	8402	Chimney Support Brace Kit	23	2900002	PEX Piping Clip Gun	7
4357	Latch Spring Clip	19	8470	Fuse, 1-A Slow Blow	18	2900003	PEX Piping Clips, 100 qty.	7
4417	Door Latch, Bottle Green	26	8560	Firebrick	19	4050001	Ceramic Refractory Grate - Upper, E-Classic 1450	19
4472	Ratchet Cinch Tool	6	8563	Draft Inducer Fan (only)	17, 19	4050002	Ceramic Refractory Grate - End Cap, E-Classic 1450	19
4500	Fuse, 5-A	16	8838	Ignitor Burner Gasket	20	5000015	Nipple, Schedule 80, Black, 1-1/4" x 2-1/2"	10
4501	Fuse, 3-A	18	8856	Firebrick	19	5000016	90° Street Elbow, Black, 1-1/4"	10
4518	Chimney Band Clamp Kit, 8"	23	8864	Silicone Door Seal, 3/4" x 3/4" x 1 ft.	20	5000017	45° Street Elbow, 1-1/4"	10
4519	Chimney Base Brace Kit, 8"	23	8866	Turbulator, Short	21	6500000	Chimney Tee - E-Classic 1400, 2300, 2400	22
4527	Relay Kit - Classic models	18	8867	Turbulator, Medium	21	6500001	Chimney Tee - E-Classic 3200	22
4528	Relay Kit - Dual Fuel Ready models (except CL 7260)	18	8868	Turbulator, Long	21	6500002	Chimney Extension, 4'	22
4536	Hopper Extension Kit - Green	24	9145	Burn Chamber Gasket Only, M250 models	26	6500004	Chimney Extension, 4'	22
4537	Hopper Extension Kit - Terra Brown	24	9220	Vent Cap - M250	24	8200008	Non-programmable 24-Volt Thermostat	3, 13
4554	Chimney Support Brace Kit	23	9254	Inspection Window, 2" x 2"	26	8200012	3-Conductor Shielded Cable, 100-ft roll	21
4756	Relay Kit - CL 7260 models	18	9257	Firebox Temp Sensor, M250	26			
4928	Brass Adapter, 3/4" female hose x 3/4" male pipe	12	9263	Push-fit Fittings Water Heater Kit	15			
4929	Brass Adapter, 3/4" male hose x 3/4" male pipe	12	9264	Connector, Straight, 3/4" x 3/4" MIP	15			
4976	Copper Tee, 1" x 1" x 1/2"	10	9265	Elbow, 3/4" x 3/4"	15			
5013	Burner Auger Motor Key	25	9268	Air Proving Switch Replacement Kit	25			
5032	Clip	17	9299	Burn Chamber w/Gasket, M250 models	26			
5052	Indoor Water Temperature Indicator Kit	16	9364	Ignitor Wire Assembly - M175	25			
5348	Cap, Brass, 3/4"	10	9372	Isolation Auger Motor Kit (includes gasket), M175	25			
5349	Washer, 3/4"	10	9373	Isolation Auger Motor Kit, (includes gasket), M250	25			
5367	Brass Coupling, 3/4" thread	12	9423	Combustion Fan Kit	25			
5459	Pipe Plug Wrench Set	10	9439	Cleaning Rod, E-Classic	21			
5549	Draft Inducer, CL 7260 High Output	17	9458	Auxiliary Auger Vibrator w/Timer Kit	24			
5567	Gas Hose w/Regulator	25	9504	Relay	25			
5575	Door Lock Kit, for steel-door CL 7260 and Pallet Burner	17	9527	Inspection Window, 2" x 3"	26			
			9528	Inspection Window Gasket	26			
5634	Plate Exchanger, 10 x 20-40, 1-1/2" Port	8	9535	Chimney Band Clamp Kit, 6"	22, 28			
5635	Plate Exchanger, 10 x 20-50, 2" Port	8	9542	Ignitor Wire Assembly - M250	25			
5636	Plate Exchanger, 5 x 12-50, 1-1/4" Port	8	9544	Ignitor Spark Plug Wire only, 19" - M250	25			
5637	Plate Exchanger, 5 x 12-70, 1-1/4" Port	8	9597	Heat Exchanger Mounting Kit	8			
5642	Brass Clamp Fittings, 1"	6	9624	Tee, Brass, 3/4"	10			
5643	Brass Clamp Fittings, 1-1/4"	6	9660	48-Bushel Hopper Kit - Terra Brown and Taupe	24			
5670	PEX 1-1/4" Pipe, 150'	12	9691	Hopper Vibrator Kit	24			
5712	Snap Disc, 145-160 F.	18	9701	Burner Auger, M175	26			
5734	Plate Exchanger, 5 x 12-6, 3/4" Port	8	9702	Burner Auger, M250	26			
5738	Plate Exchanger, MPN 5 x 12-10, 1" Port	8	9710	Aerator, Stainless Steel	25			
5744	Plate Exchanger, 5 x 12-30, 1" Port	8	9760	48-Bushel Hopper Kit - Green and Olive Gray	24			
5775	Time Delay Relay	18	9787	Burner Auger Motor	25			
5807-011	Plate Mounting Bracket	8	9804	Bag Holder Kit	24			
5842	Plate Exchanger, MPN 5 x 12-24, 1-1/4" Port	8	9896	Ignitor - M250	25			
5871	Brass Swing Check Valve, 1-1/4"	11	10137	Ceramic Refractory Grate - E-Classic 2400	20			
5907	Brass Pipe Union, 3/4"	10	10420	Grate Rod	19			
5908	Brass Pipe Union, 1"	10	10473	Gas Burner Valve	19, 25			
5909	Brass Pipe Union, 1-1/4"	10	10486	LED, Roof Panel	21			
5918	Fin Comb	16	10487	LED, Door	21			
5925	Cinch Tool	6	10489-SP	3-Conductor Shielded Cable, 1000-ft roll	21			
5926	PEX Stainless Steel Clamp Crimp Ring, 1"	6	10508	Chimney Extension, 4'	22			
5927	PEX Stainless Steel Clamp Crimp Ring, 1/2"	6	10509	Chimney Locking Band	22			
5978	Central Boiler Clamp, 1"	6	10588	Natural Gas Conversion Kit, E-Classic 1400/2400	19			
6054	Temp. Gauge, 1/8" MPT	16	10598	Natural Gas Conversion Kit	19			
6146	Dust Cap	17	10639	Curved Refractory Only	21			
6165	10" Cover for Chimney Tee (p/n 6159)	22	10691	Wonder Bar	21			
6172	Elbow, 8", 45-degree	22	10700	Fusion Combustor Kit	21			
6173	Chimney Section, 8" x 24" for Tower Installation	22	10702	Fusion Combustor Kit	21			
6179	Burn Chamber Gasket Only, M175 models	26	10774	Chimney Rain Cap, 8"	22			
6257	Gas Ignition Module	19, 25	10775	8" Cover for Chimney Tees (p/n 10510 and 11265)	22			
6287	Insulation, Door - M175	24	10835	Pulse Timer Kit	20			
6435	Turbulator - M175	26	10844	Spacer Bar Kit	21			
6497	Contact Block	18						

DEFINITIONS

ASTM

American Society for Testing and Materials. Publishes standard specifications for terminology, labeling, testing and production.

British Thermal Unit (Btu)

The British thermal unit is a unit of measure equal to the amount of heat necessary to raise the temperature of one pound of water one degree Fahrenheit.

Conduction

A process of heat transfer whereby heat moves through a material or between two materials that are in direct contact with each other.

Convection

The transfer of heat by movement of a liquid or a gas. Natural Convection is a result of movement caused by changes in density as temperature changes within a fluid medium such as a liquid or a gas. Forced Convection is the result of mechanical force moving a fluid or gas.

Crimp

An insert fitting for Central PEX tubing. A crimp requires a crimp ring or clamp of comparable quality.

Cross-Linking

A chemical process that changes the molecular structure of a plastic material by linking otherwise independent hydrocarbon chains. Cross-Linking creates a three-dimensional network of hydrocarbons.

□□**33**□□□□**3**□**3**□□□□**3**□□□

The difference in temperature between two opposing masses used to describe the potential that exists for heat transfer.

-**0**□

Female iron pipe thread.

-□□

Female American National Taper Pipe Thread.

□□□□

Abbreviation for high-density polyethylene.

□**LHK**□□**LZZ**□□**L**

The pressure available at the outlet side of a pump, or inlet side of a flow-conducting system. It is expressed in feet of head, which is the height of a column of water that can be supported by a pump against standard atmospheric pressure.

□**LH PUK3VHK**

The amount of energy (in Btu/hr) required for space heating.

□**LH 3VZZ**

The transfer of heat from a contained space to the atmosphere surrounding it. Heat loss is the result of thermal conductivity through walls, windows, roofs and other building envelope components, as well as infiltration losses due to the exchange of inside air with outside air.

Infiltration Losses

The loss of heat energy due to infiltration which is expressed in Btu/hr. Infiltration losses are calculated from the air changes per hour, differential indoor/outdoor temperature and the heat carrying capability of the lost air.

Mean Radiant Temperature

The average temperature of all the surfaces in a room.

□□□

Male American National Taper Pipe Thread.

□□□

American National Taper Pipe Thread is a standard thread used in the US.

□□

Abbreviation for polyethylene.

□**LPTL**□□(□**LH**

Describes the first four feet around the exposed perimeter of the slab.

□□□

Abbreviated for cross-linked polyethylene.

□□**LZZ**□□**L3VZZ**

The loss of fluid pressure between any two points in a flow-conducting system, expressed in pounds per square inch (psi). The loss of pressure is caused by friction against the tubing walls and is further influenced by the tubing size, length and texture of the inside wall of the tube, fittings, valves and other components. Pressure loss is also influenced by the temperature and viscosity of the fluid.

R-Value

A measure of a material's ability to resist the flow of heat. R-Value is expressed in Btu/hr/ft² and calculated by the formula 1/U=R.

Radiation

The process in which energy in the form of rays of light or heat is transferred from body to body without heating the intermediate air acting as the transfer medium.

Sweat Fitting

Soldered copper pipe fitting.

Upward Load

The amount of Btu•hr required to overcome the envelope losses of the room.

Under-Slab Insulation

The amount of insulation (expressed in R-Value) under the interior area of the slab.

Thermal Conductivity (K)

A property of materials that indicates the amount of heat (in Btu) that penetrates one square foot of a uniform material one inch thick in one hour for each degree Fahrenheit difference in temperature between the surfaces. It is expressed in Btu/(hr/ft²/°F). The thermal conductivity of PEX is 0.22 Btu/(hr/ft²/°F).

Thermal Mass

Any material used to store heat energy or the affinity for heat energy.

U-Value

The capability of a material to transfer heat. Used to describe the conductance of a material or composite of materials in construction. U-Value is expressed in Btu/hr/ft² and is the inverse function of R-Value.

Velocity

The speed of fluid at a specific flow, expressed in feet per second (fps or ft/sec).

Zone

An area of a radiant panel served by one or more loops, and individually controlled (either manually or automatically).